



Theses and Dissertations

2013-12-20

Ecology, Phylogenetics, and Conservation of *Draba asterophora* Complex: A Rare, Alpine, Endemic from Lake Tahoe, USA

Emily Ruth Smith Putnam
Brigham Young University - Provo

Follow this and additional works at: <https://scholarsarchive.byu.edu/etd>



Part of the [Animal Sciences Commons](#)

BYU ScholarsArchive Citation

Putnam, Emily Ruth Smith, "Ecology, Phylogenetics, and Conservation of *Draba asterophora* Complex: A Rare, Alpine, Endemic from Lake Tahoe, USA" (2013). *Theses and Dissertations*. 3904.
<https://scholarsarchive.byu.edu/etd/3904>

This Dissertation is brought to you for free and open access by BYU ScholarsArchive. It has been accepted for inclusion in Theses and Dissertations by an authorized administrator of BYU ScholarsArchive. For more information, please contact scholarsarchive@byu.edu, ellen_amatangelo@byu.edu.

Ecology, Phylogenetics, and Conservation of *Draba asterophora* Complex:

A Rare, Alpine, Endemic from Lake Tahoe, USA

Emily Smith Putnam

A dissertation submitted to the faculty of
Brigham Young University
in partial fulfillment of the requirements for the degree of

Doctor of Philosophy

Loreen Allphin, Chair
Eric Jellen
Brock McMillan
Leigh Johnson
Mikel Stevens

Department of Plant and Wildlife Sciences

Brigham Young University

December 2013

Copyright © 2013 Emily Smith Putnam

All Rights Reserved

ABSTRACT

Ecology, Phylogenetics, and Conservation of *Draba asterophora* Complex: A Rare, Alpine, Endemic from Lake Tahoe, USA

Emily Smith Putnam
Department of Plant and Wildlife Sciences, BYU
Doctor of Philosophy

Rare, alpine, endemic species are particularly at risk for extinction. Alpine environments are especially vulnerable to climate change and human impacts, such as ski resort development and snowmaking. *Draba asterophora* Payson is a rare, alpine species that occurs only in three disjunct mountain-top regions surrounding Lake Tahoe. It is currently threatened by human impacts, such as ski resorts, as well as indirect influences of climate change and therefore in need of better understanding for conservation purposes. *Draba asterophora* may be able to serve as a case study for other similarly vulnerable, rare, alpine, endemic species with conservation needs. We utilized demographic, ecological, phylogenetic, and cytogenetic data to better understand *D. asterophora*'s life history, habitat requirements, and delineate species boundaries.

Draba asterophora occurs in three population clusters surrounding Lake Tahoe, segregated into two varieties, variety *asterophora* in the north (N) and south (S) and variety *macrocarpa* C. L. Hitchcock in the southwest (Sw). Populations exist on ski resort property in the north and south (variety *asterophora*) regions and thus face more threats. Therefore, these regions were the focus of long-term monitoring over a four year period. We assessed various morphological traits, survivorship and density estimates in these two population clusters (north and south). We created projection matrices for each population cluster and calculated finite rates of increase (λ), as well as reproductive and survivorship rates. The population projection matrices estimated growth rates close to 1.00 for both clusters (S: $\lambda=0.977$; N: $\lambda=1.014$), although neither cluster had reached a stable population structure. Plants in the north tended to be more robust, having more rosettes, inflorescences, flowers and fruits than the plants in the south. However, the plants in the northern population cluster did not have significantly higher brood sizes and the southern plants actually had larger seed to ovule ratios than those in the north (S: $\bar{x} = 0.3871$; N: $\bar{x} = 0.346$). These results may be in part influenced by habitat differences (e.g. greater water availability in the north), specific site microclimate/microhabitat differences, genetic drift, and/or possibility polyploidy vigor (the northern cluster is tetraploid). However, as an autopolyploid, the NE cluster may have some difficulties with pairing in meiosis which could also contribute to its reduced seed to ovule ratios. Although the populations were found to be fairly stable currently, *D. asterophora* var. *asterophora* is potentially quite vulnerable to disturbance. All of the monitored populations in both clusters existed in small populations with low local densities confined to narrow geographic boundaries, and exhibit low fecundity. Because the taxon relies on survivorship of adults for population stability rather than new recruits, it is crucial to maintain stable adult populations in conservation efforts. *Draba asterophora* is similar to other alpine species tend, exhibiting high adult survivorship with low fecundity.

We also examined the habitat requirements of *D. asterophora* by characterizing the abiotic habitat (soil chemical and texture analysis and site features such as aspect, slope, elevation) and the vegetative communities in *D. asterophora* sites. *Draba asterophora* sites all have fairly similar abiotic and biotic habitats despite large geographical separation, although some specific sites have unique characteristics as well. *Draba asterophora* habitats consist of steep, granitic slopes in the subalpine conifer zone with little understory. *Draba asterophora*'s community may be facilitated by the diversity-stability hypothesis, as *D. asterophora* abundance (cover and/or frequency) was positively correlated with species richness and diversity, but negatively correlated with total vegetative cover (relative cover). In addition, *D. asterophora* has greater seed production (both seed/ovule ratio and brood size) in areas with greater species diversity. *Draba asterophora* does not appear to have many specific soil composition requirements or specific interspecific interactions, but generally occurs in diverse communities, albeit somewhat sparsely populated, in relatively open north-facing alpine habitats on steep granitic slopes. Changes in vegetation, topology and/or snow cover, due to disturbances such as grading, erosion, or snowmaking, may be detrimental to *D. asterophora* by rendering its habitat unsuitable. Therefore, *D. asterophora* habitat should be protected from further human impacts.

Draba; the largest and most diverse genus in Brassicaceae, the mustard family, has complex phylogenetics due to its high degree of reticulate evolution, polyploidization, rarity and endemism. The *D. asterophora* complex has not been included in previous phylogenetic analyses. Only the northern population has been examined cytologically ($2n=40$). Thus, its taxonomy is poorly understood. We utilized one nuclear molecular marker, ITS, as well as two new chloroplast markers, *trnS-G* and *trnH-psbA*, to help resolve complex phylogenetic relationships and delimitation species boundaries within the *D. asterophora* complex. In addition, we examined the cytogenetics of all three population clusters to determine any differences in ploidy levels exist. The *D. asterophora* complex appears to be composed of three separately evolving trajectories differentiated by separate geographic regions surrounding Lake Tahoe, CA/NV. This is supported by both phylogenetic analyses as well as cytology. The combined DNA concatenated analysis demonstrated that all three regions form separate branches within the *D. asterophora* clade. Cytologically, chromosome counts were distinct in all three regions, with the southern cluster being a diploid ($2n=20$), the northern cluster an autotetraploid ($2n=40$), and the cluster in the southwest (variety *macrocarpa*) an autooctoploid ($2n=80$). Based on these findings, we recommend that the three population clusters be treated as distinct taxonomic entities for conservation purposes. This demonstrates the importance of considering phylogenetics and ploidy levels, even of autopolyploids, in determining taxonomy, especially for rare, endemic species with disjunct habitats.

Overall, this research suggests that the three geographic regions of the *D. asterophora* complex are distinct demographically and on their own evolutionary trajectories. Conservation efforts need to be targeted towards separate management of each population cluster. Maintaining stable adult populations, diverse plant communities, and preventing further destruction of habitat are the key conservation suggestions for *D. asterophora*.

Key Words: *Draba asterophora*, demography, ecology, habitat, phylogenetics, cytogenetics conservation

ACKNOWLEDGEMENTS

I wish to express my sincerest appreciation to my advisor, mentor, and friend, Dr. Loreen Allphin for her dedication and commitment to helping me complete this project. Not only has she provided numerous hours devoted to this research, she has provided encouragement, enthusiasm and her expertise. I am also grateful to all of my committee members for their assistance. I am particularly grateful to Dr. Leigh Johnson who has helped guide me in lab research on many occasions and allowed me to use some of his lab space and equipment. I am indebted to Brigham Young University for providing outstanding facilities, including a state of the art Sequencing Center. I am grateful to Elizabeth Bergstrom and others at Lake Tahoe Basin Management, U.S. Forest Service for facilitating and helping me complete the field research. I appreciate both Mt. Rose Ski Resort and Heavenly Ski Resort's for funding and cooperation with this research. I am indebted to many fellow students (both graduate and undergraduate) who assisted in the lab and field research, including Danny Nielson, Brianne Edwards, and Cassey Day, among others. I also wish to express thanks to my parents, Christina Call and Dr. Allphin for reading many drafts of my dissertation. Lastly, I am grateful and indebted to my family for their patience and support in completing this project.

TABLE OF CONTENTS

Title Page	i
Abstract	ii
Acknowledgements	iv
Table of Contents	v
List of Tables.....	viii
List of Figures	x
Ch 1: Demography and Life History Characteristics of the rare and endemic <i>Draba</i>	
<i>asterophora</i> var. <i>asterophora</i> (Tahoe Star Draba).....	1
Abstract.....	2
Methods	6
Study Area.....	6
Field Sampling Methods	7
Density Methods.....	8
Morphological and Reproductive Methods	9
Demographic and Life History Methods	10
Results	13
Density.....	13
Morphological and Reproductive Variation.....	14
Demography and Life History.....	15
Discussion.....	17
Implications for Conservation and Management of <i>Draba asterophora</i> var. <i>asterophora</i>	24
Literature Cited	26
Tables and Figures.....	33

Ch 2: Habitat Characteristics of the Rare and Endemic..... <i>Draba Asterophora</i> (Tahoe Star Draba).....	42
Abstract.....	43
Methods	47
Study Area.....	47
Selection of Sampling and Long-Term Monitoring Sites.....	47
Field Sampling.....	49
Abiotic & Soil Characterization Methods	49
Vegetative Community Characterization Methods.....	50
Results	52
Abiotic & Soil Characterization Results	52
Vegetative Community Characterization Results.....	55
Discussion.....	57
Abiotic Variables.....	57
Vegetative Community Discussion	60
Implications for Managing Rare Alpine Species.....	62
Literature Cited	65
Tables and Figures.....	72
Ch 3: Species Delineation of the <i>Draba asterophora</i> Complex Utilizing Phylogenetic and Cytogenetic Data	80
Abstract.....	81
Methods	85
Taxon Sampling.....	85
DNA Sequencing.....	86

Phylogenetic analyses.....	88
Cytology.....	88
Results	89
Discussion.....	91
Implications for Conservation	96
Literature Cited	98
Figures and Tables.....	106

LIST OF TABLES

Chapter 1

TABLE 1. Density estimates (plants per m ²) of <i>D. asterophora</i> var. <i>asterophora</i> . Based on Diggle's (1975) method of combining results from the point-quarter and nearest-neighbor methods utilizing post-data acquisition cut-offs with a correction factor (Mitchell, 2007) for subsequent missing data.	33
TABLE 2. Vegetative and reproductive plant characteristics for <i>Draba asterophora</i> var. <i>asterophora</i> by site. Different letters in a row indicate statistically significant differences ($P \leq 0.05$)	34
TABLE 3. Population projection matrices and main demographic results for the <i>Draba asterophora</i> var. <i>asterophora</i> populations that were chosen for long-term monitoring for years 2005-2008 (data pooled). The corresponding λ value is shown in the footnote, q_x = mortality per size class, w = projected stable stage class distribution, v =reproductive values per stage class, n_x = total plants sampled per size class from which transition probabilities were calculated.....	35
TABLE 4. Vital rates of growth and reproduction as calculated based on population projection matrices of <i>Draba asterophora</i> var. <i>asterophora</i>	36
TABLE 5. Elasticities per demographic process (a) and size class (b) corresponding to the projection matrices for <i>Draba asterophora</i> var. <i>asterophora</i>	37

Chapter 2

TABLE 1. Abiotic characteristics by regions and sites that support <i>Draba asterophora</i> in Washoe and Douglas counties, NV and El Dorado country, CA. Each value represents an average of at least five samples from each site. Means followed by the same letter do not	
--	--

differ at the $P < 0.05$ level of significance, whereas exclusively different letters indicate significant differences ($P < 0.05$)..... 72

TABLE 2. Percent cover of abiotic, litter, and biotic material in *Draba asterophora* habitat along with relative percent *Draba asterophora* cover and frequency 73

TABLE 3. Percent relative frequency and cover of prevalent species in *Draba asterophora* communities ranked by average relative frequency..... 74

Chapter 3

TABLE 1: Information on Taxon Sampling of *Draba* species and outgroup here studied.

Species and associated *genBank* accession numbers together with some relevant characters sates under study. FC = Flower color (P=purple; W = white; Y = yellow); CC = Chromosome count. (continued on following pages) 106

LIST OF FIGURES

Chapter 1

- Fig. 1. Map of study area (Photo credit: google maps; <http://maps.google.com>) 38
- Fig. 2. Point-Quarter Method Diagram (Cottam and Curtis, 1956)..... 39
- Fig. 3. Life-cycle graph for the populations of *Draba asterophora* var. *asterophora* that were studied through long-term monitoring. 40
- a) Southeast (SE) cluster of Lake Tahoe (including two sites in Heavenly Ski Resort and Freel Mt. outside of the ski resort) 40
- b) Northeast (NE) cluster of Lake Tahoe (including two sites in Mt. Rose Ski Resort and Mt. Rose Mt. outside of the ski resort). 40
- Nodes represent the stage classes (projected seedlings and 7 observed size classes); the relative size corresponds to the stage structure of the population cluster. The arrows and associated values represent the transition probabilities or contributions to specific stages. F= fecundity (yellow), P=permanence (black), G=growth (green, growth to any larger class), S=shrinkage (red, proportion shrinking to all smaller stage classes)..... 40
- Fig. 4. Climatic Diagram: Monthly average temperatures and precipitation at Mt. Rose Ski Resort (north) and Heavenly Ski Resort (south). SWE=snow water equivalent. 41

Chapter 2

- Fig. 1. Map of *Draba asterophora* population clusters. (Photo credit: google maps; maps.google.com) 76
- Fig. 2. Nested Frequency Quadrat Frames or pitchfork frames (Smith et al. 1987)..... 77
- Fig.3. Unweighted Pair Group Method with Arithmetic Mean (UPGMA; Ward, 1963) by region in terms of soil composition based on a Rusicka similarity matrix (Ruzicka, M.

1958). The region of each site is indicated in parentheses. The southwest variety *macrocarpa* is also indicated in parentheses, all others are variety *asterophora*. 78

Fig. 4. Unweighted Pair Group Method with Arithmetic Mean (UPGMA; Ward, 1963.)

Cluster Analysis of vegetative community by site according to a Rusicka similarity matrix (Ruzicka, M. 1958) based on relative frequencies of prominent species at each site. (Sw=southwest cluster) 79

Chapter 3

Fig. 1. Map of the three geographically distinct clusters of *D. asterophora* surrounding Lake Tahoe. (Photo credit: google maps; maps.google.com)..... 109

Fig. 2. Phylogenetic tree based on the ITS dataset (Bayesian posterior probabilities shown above branches). The only difference in species placement between the three types of analyses, was that in maximum likelihood analysis *D. paysonii2* emerged sister to *D. mogollonica* and *D. sphaerdes* was sister to the entire branch (versus *D. paysonii2* and *D. sphaeroides* forming their own separate branch). W = white flowers; Y = yellow flowers; E= euploid chromosome counts (x=8); A=aneuploid chromosome counts (x≠8); NA=North America, GL=Greenland, Eu=Europe. For *D. asterophora*., N=northern population cluster, S=southern population cluster, SW=southwest population cluster (variety *macrocarpa*). 111

Fig. 3. Phylogenetic tree based on chloroplast molecular marker *trnH-pabA*. (**Bayesian posterior probabilities/Maximum Likelihood** above the branches). W = white flowers; Y = yellow flowers; E= euploid chromosome counts (x=8); A=aneuploid chromosome counts (x≠8), NA=North America; IMW=Intermountain West; GL=Greenland. For the *D.*

asterophora population clusters, N=northern cluster, S=southern cluster, Sw=southwest cluster (variety *macrocarpa*)..... 112

Fig. 4. Phylogenetic tree based on the chloroplast molecular marker *trnS/G* (**Bayesian posterior probabilities/Maximum Likelihood** above branches). W =white flowers; Y =yellow flowers; E= euplod chromosome counts ($x=8$); A=aneuploid chromosome counts ($x\neq 8$); IMW=Intermountain West; NA=north America. For the *D. asterophora* population clusters, N=northern cluster, S=southern cluster, SW=southwest cluster (variety *macrocarpa*)..... 113

Fig. 5. Phylogenetic tree based on the combined concatenated data set (**Bayesian posterior probabilities/Maximum parsimony/Maximum likelihood bootstrap probabilities** above the branches). W = white flowers; Y = yellow flowers; E= euplod chromosome counts ($x=8$); A=aneuploid chromosome counts ($x\neq 8$). In reference to the *D. asterophora* population clusters, N=northern population cluster, S=southern population cluster, SW=southwest population cluster (variety *macrocarpa*)..... 114

Fig. 6. Chromosome counts for *Draba asterophora*. a and b. *Draba asterophora* var. *asterophora* meiotic pollen cells in anaphase I from the southern region: a. shows diploid chromosome counts ($2n=20$, $x=10$), b. demonstrates triploid chromosome counts from the Star Lake population. c and d. *Draba asterophora* var. *asterophora* meiotic pollen cells from the northern region (Bruce ski run site) indicating autotetraploidy. c. meiotic pollen cell in anaphase I showing $n=20$, d. meiotic pollen cell at diakinesis with nine quadrivalents and two bivalents. e. and f. *Draba asterophora* var. *macrocarpa* meiotic pollen cells in prophase I from the southwest region (Ralston Peak) demonstrating octoploid chromosome counts. (Photos courtesy of Michael Windham, Ph.D.) 115

Fig. 7. SEM micrographs of pollen in *Draba asterophora* (all at 1200x magnification). a. pollen from the diploid southern population cluster. b. pollen grains from the tetraploid northern population cluster. c. and d. pollen from the octoploid southwestern population cluster (var. *macrocarpa*)..... 116

CH 1: DEMOGRAPHY AND LIFE HISTORY CHARACTERISTICS OF THE
RARE AND ENDEMIC *DRABA ASTEROPHORA* VAR. *ASTEROPHORA*
(TAHOE STAR DRABA)

ABSTRACT

Rare, endemic, alpine species are particularly vulnerable to extinction, and there is a paucity of detailed demographic studies on such species to appropriately guide conservation efforts. *Draba asterophora* var. *asterophora* Payson, Tahoe Star Draba, is a rare, alpine endemic in need of a more thorough understanding of its basic biology and life history to aid conservation efforts. It can also serve as a case study for other rare alpine endemics in need of conservation plans and add to the demographic literature. *Draba asterophora* var. *asterophora* is endemic to the Sierra Nevada Mountains surrounding Lake Tahoe, NV/CA, one cluster to the north (N) and one cluster to the south (S). Both regions have populations that occur on ski resort properties, increasing the potential for impacts to the species. Populations of *D. asterophora* var. *asterophora* were monitored for four years for various morphological traits, survivorship and density estimates in both the north and south population clusters. We created population projection matrices for each population cluster and calculated finite rates of increase (λ), as well as reproductive and survivorship rates. The population matrices estimated population growth rates close to 1.00 for both clusters (S: $\lambda=0.977$; N: $\lambda=1.014$), although neither cluster had reached a stable stage distribution in their populations. Net reproductive values (R_0) were significantly different between the two population clusters (N: $R_0= 1.25$; S: $R_0=0.71$). The southern cluster had a value low enough to suggest that these populations may not be able to replace themselves. Plants in the north cluster tended to have more rosettes, inflorescences, flowers and fruits than the plants in the south. Habitat differences, such as increased water availability, genetic drift, or a polyploidy advantage (for the northern cluster) may account for some of these morphological differences. However, the northern cluster did not have significantly higher brood sizes and the southern cluster had larger seed to ovule ratios than the north (S: $\bar{x} = 0.387$; N: $\bar{x} = 0.346$). Using regression analyses, we found that many reproductive traits (i.e. inflorescences, projected seeds) were also correlated with number of rosettes per plant. Local population density estimates were fairly low at all sites (0.39-2.98 plants/m²), as were estimates of fecundity (S: 0.0165 to 0.337; N: 0.0068 to 0.823). However, estimates of survival rates were fairly high (S: 0.898; N: 0.891), following typical demographic patterns seen for other alpine species. Overall, *Draba asterophora* var. *asterophora* is potentially quite vulnerable to extinction. Survivorship of established adults, particularly mid-large individuals, in *D. asterophora* var. *asterophora* populations appears to influence population persistence more than new recruitment of individuals based on sensitivity analyses. This along with low estimated fecundity rates, suggests that reestablishment of populations would be unlikely if large quantities of adult plants are lost. Therefore, it is crucial that established adults in intact populations be maintained and preserved. Any direct negative impacts to *D. asterophora* var. *asterophora* must be avoided. Similar management approaches, focusing conservation efforts on preserving established adults in their microhabitats, may be helpful to other endemic, alpine species.

The Tahoe Star Draba (*Draba asterophora* var. *asterophora* Payson) is a rare, endemic perennial herb that occurs in a complex of two population clusters in the Sierra Nevada Mountains near Lake Tahoe (Fig. 1, one to the north and one to the south of Lake Tahoe). The taxon is confined to a narrow range of subalpine/alpine habitats (above 2500m elevation). It is typically found on granitic, north-facing slopes with sparse understory near mountain peaks (Hickman 1993).

Draba asterophora var. *asterophora* is currently listed as a threatened species on the Nevada sensitive species list (Nevada Native Plant Society, NNPS, Status Lists 2010). In addition, it is also included in California Native Plant Society's (CNPS) inventory of rare and endangered plants on the 1B.2 list, indicating it is considered rare, threatened or endangered (CNPS 2012). Globally, it is ranked as a vulnerable species, indicating that it is likely to move into endangered if current causal factors continue (1997 IUCN Red List of threatened plants; Walter and Gillett 1998). This corresponds to the TNC category G2T2 species, which is defined as being imperiled, at high risk of extinction due to a restricted range, very few populations, steep declines, or other factors (Walter and Gillett 1998).

Much of *D. asterophora*'s habitat is on ski resort property that is currently at risk due to ski run expansion and alterations (Engelhardt and Gross 2011). Although initial clearing of trees (in 1950s) for ski runs may have opened more habitats for *D. asterophora* var. *asterophora*, more recent activities seem to have had negative effects. In 2004, one of the largest sub-populations in the north cluster was substantially impacted when the lower half of a ski run (Bonanza) in Mt. Rose Ski Resort was graded. An estimated 26,000 individual plants were taken during this grading (JBR Environmental Consultants, Inc. 2004). Remediation efforts of transplantation have been unsuccessful Other human activities that pose direct threats (trample, uproot) include

recreational activities such as hiking, trail construction, equestrian use, grazing and snowmobile use (Engelhardt and Gross 2011).

Global climate change may also disrupt *D. asterophora* var. *asterophora*'s habitats and contribute to encroachment of lower elevation species (Kopp and Cleland 2013). Climate change is speculated to particularly impact plant species in vulnerable regions, such as alpine and arctic habitat (Callaghan et al. 1995; Guisan and Theurillat 2000, 2001; Pauli, Gottfried, Grabherr 1996). Thus, rare species that rely on specialized habitats are especially at risk for extinction when these habitats are in decline or shifting due to these global climate changes (Hughes 2002; Romme and Turner 1991; Davis and Shaw 2001).

In light of the increasing threats to the taxon, the US Forest Service has been mandated to develop an appropriate, individualized management plan for *D. asterophora* var. *asterophora*'s conservation. However, the basic biology of the taxon is relatively unknown. Thus, conservation/management strategies would be improved by a better understanding of *D. asterophora* var. *asterophora*'s basic biology.

Understanding population dynamics and life history characteristics is considered fundamental to the conservation of rare plant species (Baskin and Baskin 1986; Fiedler, Knapp and Fredericks 1998). Certain life stages may be more critical for survivorship and population persistence, so identifying these critical developmental stages could impact conservation/management strategies. It is perceived that human disturbances and climate change are impacting *D. asterophora* var. *asterophora*, both directly and indirectly, which may further exacerbate its rarity and affect its demography.

Understanding the demography of *D. asterophora* var. *asterophora* is crucial for the development of management strategies to maximize long-term population persistence

(Simberloff 1988; Mills 2012). In addition to being an asset to understanding its unique life history and to generating an individualized conservation plan, this research will contribute to the growing literature on demography, particularly of rare alpine species (Bevill and Louda 1999; Falk and Holsinger 1991; Gabrielová et al. 2013). It also provides a demographic example of a species complex that is restricted to alpine environments.

Thus, this study was initiated in conjunction with the USFS in order to provide more in-depth information about *D. asterophora* var. *asterophora*'s basic life-history and demography to assist in the development of a much needed appropriate management plan. We established three main objectives for this study:

1) DETERMINE DENSITY OF *DRABA ASTEROPHORA* VAR. *ASTEROPHORA*.—We focused on determining the density of *Draba asterophora* var. *asterophora* at long-term monitoring populations both on and off ski resort property in both the northern and southern regional clusters surrounding Lake Tahoe.

2) CHARACTERIZE BASIC MORPHOLOGY OF *DRABA ASTEROPHORA* VAR. *ASTEROPHORA*.—Particularly, we wanted to characterize the basic morphological vegetative and reproductive traits of *Draba asterophora* var. *asterophora* and compare these between the two geographically separated clusters. In addition, we wanted to examine any relationships between morphological and reproductive variables.

3) ANALYZE POPULATION DYNAMICS OF *DRABA ASTEROPHORA* VAR. *ASTEROPHORA*.—We analyzed the population dynamics of *Draba asterophora* var. *asterophora* by constructing stage-specific population projection matrices. We used these to estimate the finite rate of increase (λ) and generate life cycle diagrams for each population cluster. These analyses can also add to the demographic literature on rare species.

METHODS

Study Area

Draba asterophora var. *asterophora* is located in mountain islands surrounding Lake Tahoe in two general regions (north and south; Fig. 1). In each cluster some populations are confined to ski resort property, while other populations are located outside of the ski resort property in more remote areas. We established long-term monitoring transects at three sites in each of the two regions (two within ski-resort property and one outside).

NORTHERN REGION.—The north population cluster occurs primarily on ski resort property at Mt. Rose Ski Resort (both on private and U.S. Forest Service land on Slide Mountain in Washoe County, Nevada, USA). *Draba asterophora* var. *asterophora* is found on currently utilized ski runs, and on nearby Mt. Rose Mountain, a U.S. Forest Service area outside of the Mt. Rose Ski Resort property (Fig. 1). A “valley” (lower elevation) of unsuitable habitat matrix divides the ski resort populations on Slide Mountain from the populations on Mt. Rose Mountain, which extend up to the top of Church Peak (3235m).

We established long-term monitoring sites at two sub-populations on ski runs (Bruce and Bonanza) at Mt. Rose Ski Resort and one outside of the ski resort (nearby the Mt. Rose Trail). We chose these sites because they were accessible and appeared to be the largest populations in the area. In addition, Mt. Rose Ski Resort had graded the lower half of the population on the Bonanza ski run in 2004. Thus, we intentionally included the remainder of the Bonanza population. Mount Rose Ski Resort also has indicated intentions to grade other ski runs, including the Bruce ski run, where we established another long-term monitoring site (JBR Environmental Consultants, Inc. 2004).

SOUTHERN REGION.—In the southern cluster, all of the sub-populations occur on U.S. Forest Service property (Lake Tahoe Management Basin Unit) in El Dorado County, California and Douglas County, Nevada, USA. Some populations fell within the Heavenly Ski Resort boundaries including: active ski runs, roadside cuts, and out-of bounds areas. Other populations occurred in more remote sites outside of the resort at and around Freel Peak (peaking at 3316m.; including at Jobs' Peak, Jobs' Sister and Star Lake; Fig. 1). We established long-term monitoring sites at two subpopulations at the Heavenly Ski Resort (Monument Peak and East Peak) and one outside of Heavenly Ski Resort (Freel Peak; Fig. 1). Again, we choose the two ski resort populations because we were informed that these were the largest populations in the southern cluster and we could access them easily.

Field Sampling Methods

We monitored five sites beginning in 2005 (Fig. 1) and added the sixth site (Freel Peak) in 2006. Monitoring was conducted yearly through 2008. At each of the initial five sites, we tagged 50-100 individuals (Table 2) for monitoring. Due to difficulty accessing the Freel Peak, we only tagged 28 plants and monitored them for two years (2006 and 2007).

We used various length transects (~20-50 m. depended on size and shape of the population, often multiple transects per population) to estimate density and systematically select plants to be tagged. We selected four individual plants at each point every 2.5 m. along transect lines using the point-quarter method (Cottam and Curtis 1956; Fig. 2). Systematic sampling along transects allowed us to objectively capture the variation in the population, minimize biases in selecting individuals, and minimize sampling disturbance to the populations. We marked all individual plants using numbered aluminum tags held with galvanized nails at the bases. Unfortunately due to the rocky soil, steepness of the sites, and wind/snowmelt and other potential factors, some of

the nails became dislodged in subsequent years, reducing the overall number of individuals that could be tracked.

Density Methods

We used a combination of the point-quarter distance method (Cottam and Curtis 1956; Fig. 2) and nearest-neighbor (Diggle 1975) to estimate the local population density of *D. asterophora* var. *asterophora* at each of the long-term sites. We chose this method in order to minimize biases and disturbance and to maximize sampling efficiency (Krebs 1999).

We took density measurements two different years (2005 & 2007 for all sites except Freel which was taken 2006 & 2007). We marked the end points of each transect with a stake so that we could use approximately the same location the second sample. However, soil erosion from a road cut buried part of two sites (Bruce and Bonanza) in 2006, so we had to shorten transects for the second sample (2007).

For both the point-quarter and nearest neighbor density estimates, we selected points every 2.5 meters along transects. We sampled each plant once (i.e. not used as both the nearest plant for the point-quarter method and as a nearest-neighbor for a different plant for the nearest neighbor method). We applied a post-hoc cut-off distance (a distance at which searching for a closest plant should have stopped and avoid overlapping with another point's quadrats). We utilized a correction factor for any missing data and incorporated this into the calculations for both the point-quarter and nearest neighbor, to reduce the underestimation biases (Mitchell 2007).

We calculated density estimates by combining both the point-quarter method (Cottam and Curtis 1956; $D = [4(4n-1)] / [\Pi * \sum(\text{distance from point to plant})^2]$ equation) and the nearest-neighbor method ($D = n / [\Pi * \sum(\text{distance between nearest neighbors})^2]$; Diggle 1975). Point quarter

tends to underestimate density in aggregated populations, where nearest-neighbor methods tend to overestimate density in aggregated populations (Diggle, 1975; Krebs, 1999). Thus, we employed Diggle's (1975) unbiased, combined estimator for population density.

Morphological and Reproductive Methods

We measured tagged individuals at each of the long-term monitoring populations of *D. asterophora* var. *asterophora* for morphological (vegetative and reproductive) characteristics. Vegetative measures included number of rosettes and rosette height. We assigned each of the tagged individuals to a one of 7 size classes based on number of rosettes each year: 1) 1 rosette, 2) 2-3 rosettes, 3) 4-5 rosettes, 4) 6-10 rosettes, 5) 11-23 rosettes, 6) 24-50 rosettes, 7) >50 rosettes. We selected the size classes based on natural divisions in the data observed in histograms.

Reproductive success was estimated using several pre-emergent indicators, including the number of inflorescences per tagged plant and the average number of flowers and fruits per inflorescence. We also calculated the percentage of flowering individuals at each of the long-term monitored populations. We counted the buds, flowers and fruits of at least three (or all if less than three) inflorescences per tagged plant in order to determine individual plant averages for these traits.

We estimated several measures for number of flowers and number of fruits per inflorescence. We computed mean flowers per inflorescence, mean fruits per inflorescence, projected mean fruits per inflorescence (for inflorescences that had buds and/or flowers), and a projected total fruits per plant. We then averaged these values across each of the populations. Based on limited data from plants sampled both in bud/flower and then in fruit in the same season, we found that

not all buds and flowers developed into fruits. We determined that a multiplier of 0.64 provided the best predictor of later fruits.

We also collected mature fruits from as many populations as possible in both regions, including some sites where we did not conduct long-term monitoring (excluding two of the long-term monitoring populations, HEP and Freel, which did not have mature fruits during times of visitation). We used these fruits to compute mean brood size (seeds per fruit) and a mean seeds per ovule ratio (S/O; Wiens, 1984) for each population and for both the northern and southern population clusters. We also used these reproductive data in a life history matrix to estimate the relative contribution of each size class to the seedling class, as a representation of fecundity. All attempts to germinate the seeds in a greenhouse failed, despite efforts to break potential seed dormancy.

We compared morphological characteristics among the individual populations using one-way ANOVAs or Chi-square tests and between the southern and northern clusters using t-tests in JMP9 (SAS Institute Inc. 2010). We also conducted regression analyses to determine any correlations between vegetative and reproductive measures (JMP9; SAS Institute Inc. 2010). We averaged all morphological characteristics across all years of sampling for each individual tagged plant to avoid non-independence in the data before running statistics to compare regions and/or sites.

Demographic and Life History Methods

We evaluated the population dynamics of *Draba asterophora* var. *asterophora* by constructing life cycle diagrams and stage-specific projection matrices for each of the population clusters (Caswell 2001).

LIFE-CYCLE SIZE (STAGE) CLASSES.—We assigned each tagged plant to one of seven size (stage) classes each year of monitoring based on number of rosettes in order to generate a life history projection matrix based on stages (Marcante, Winkler, and Erschbamer 2009; Moseley and Mancuso 1993; Caswell 2001; Dickenson et al. 2007). We evaluated each tagged plant each year to determine survival/mortality. For the individuals that survived each year, we determined whether it stayed within the same size class, grew to a larger one or shrank to a smaller size class. We noted both types of transitions between size classes (growth and shrinkage) in the population projection matrices. We excluded plants whose fates were unknown, such as those whose tags had fallen out or could not be relocated.

Although larger size classes tended to contribute more to reproduction and have a higher percentage of reproductive plants, we observed flowering inflorescences in all size classes. Therefore, the first size class, as defined as one rosette, did not appear to be an appropriate representation of a true seedling. Instead the seedlings consisted of two cotyledons and were never observed to have inflorescences their first year. Thus, we determined that a better estimate of recruitment of number of seedlings was necessary.

In order to accomplish this, we established one meter square recruitment plots (separate from the transects) at each population in 2006 and we recorded the number of new seedlings (and their fate) in each of these plots in 2007 and 2008. We used these data to better estimate the recruitment rates of new seedlings and their first year survival rates as well as to create an additional stage of projected seedlings contributed by each size class. Specifically, we used estimates of average projected fruits per individual multiplied by an estimated germination and first season survival rate, based on the recruitment plot data (Godínez -Alvarez and Jordano 2007). This calculated number of average seedlings produced by each individual in each size

class served as an estimate of reproductive success, representative of fecundity for each size class.

MATRIX ANALYSES.—We evaluated the population dynamics of *D. asterophora* var. *asterophora* by constructing population projection matrices for each population cluster using pooled data from the three sites in each cluster for 2005-2008. We computed the population projection matrices (Caswell 2001) based on survival, growth, shrinkage and estimated fecundity rates of each of the seven size classes in each of the clusters, separately. We derived all probabilities from observed survival data. Thus, we partitioned survival rates, observed for each size class, into three processes: 1) surviving and remaining in the same size class (stasis or permanence), 2) surviving and growing to a larger size class (growth), or 3) surviving and shrinking to a smaller size class. Fecundity estimates entries are presented in the 1st row of the matrix (Table 3).

We made iterations of these projection matrices to achieve a stable stage distribution and determine the finite rate of increase, λ , which is the dominant eigenvalue of the matrix, using PopTools (3.2) software (Hood 2010). We also created life-cycle diagrams for each population cluster based on these 8 x 8 projection matrices (Fig. 3) using PopTools (Hood 2010).

Each of the entries in the matrix (a_{ij}) represented the probability that individuals in a particular size class (j = columns) transition or contribute (via offspring) to another or the same size class through permanence (i = rows; Caswell 2001). Entries representing permanence were found along the main diagonal of the matrix, whereas entries in the sub-diagonal represent growth to a larger size class and entries above the diagonal (except the first row) represented shrinkage to a smaller size class.

We used the power method to obtain the dominant eigenvalue for the projection matrix (Caswell 2001), which is interpreted as the finite rate of population increase (λ). We also obtained the stable size-class distribution, represented by the right eigenvector associated to λ (w), and the size-specific reproductive values, represented by the left eigenvector (v) associated to λ (Caswell 2001). We tested for differences between projected (w eigenvector) and observed stage-class distributions using a χ^2 test (Pearson 1900).

We calculated both sensitivity and elasticity matrices (de Kroon et al. 1986, Caswell 2001) to estimate the relative changes in λ that would result from small changes in matrix entries. Elasticities provide standardized sensitivity estimates (proportional and all entries sum to unity), and can be used to compare the relative contribution or importance of each matrix entry to population growth rate (de Kroon et al. 1986, Caswell 2001). In addition, we used elasticity values to determine the relative contributions of each demographic process (growth, stasis, shrinkage, and fecundity) and size class to the growth rate (λ) by summing relevant elasticities. We calculated all eigenvalues and the elasticity matrices with Poptools (Hood 2010).

RESULTS

Density

We found low local population density at all of the sites ($\bar{x} = 0.354-2.6$; Table 1). We estimated the highest density, albeit still fairly low, at Freel ($\bar{x} = 2.6$), followed by MRT ($\bar{x} = 1.163$); the two sites outside of site resort property in the southern and northern clusters respectively. We calculated the lowest densities at HMP ($\bar{x} = 0.354$), and HEP ($\bar{x} = 0.454$), sites in the southern region on a ski resort and then Bruce ($\bar{x} = 0.56$), a site on a ski run in the north. Due to the caveats explained regarding the methods, these density calculations may be

underestimates and should be interpreted with some caution. We did not find any significant correlations found between density and any morphological characteristics of *D. asterophora* var. *asterophora*.

Morphological and Reproductive Variation

We found significant differences for many vegetative and reproductive characteristics of *D. asterophora* var. *asterophora* among the regional clusters, as well as individual populations within each cluster (Table 2). Overall, the plants in the northern cluster (N) were more robust on average than the plants in the southern cluster (S), as demonstrated by more rosettes (N: 16.72; S: 11.52), inflorescences (N: 7.3; S: 3.85), flowers (N: 6.75 S: 5.45), and fruits (fruits/plant - N:54.54; S: 21.57). Among specific sites, Bruce (a ski resort site in the northern cluster) had the highest mean values for seven of the eight morphological characteristics, often significantly higher than at other sites ($p \leq 0.05$; Table 2).

When clusters were compared for brood size, the northern and southern clusters were not significantly different (N: 2.73; S: 2.60). Among individual sites, one site in the southern cluster (a Heavenly Ski Resort ski run called High Roller, not one of the long-term monitoring sites) had the highest number of seeds per fruit ($\bar{x} = 3.45$), followed by Bruce ($\bar{x} = 3.36$) and then MRT ($\bar{x} = 3.06$). These three sites were not significantly different from each other, but they did have significantly more seeds per fruit than many of the other sites sampled, including one of the long-term monitoring sites, HMP ($\bar{x} = 2.44$; $P < 0.05$) as well as non-long-term monitoring sites.

The southern cluster had a significantly larger viable seed to ovule ratio ($\bar{x} = 0.387$) than the northern cluster ($\bar{x} = 0.346$, $P < 0.05$). Among individual sites, High Roller had the highest seed to ovule ratio ($\bar{x} = 0.54$), significantly higher than any other site where fruits were collected

($P < 0.05$). The next highest S/O ratios were observed at Bruce ($\bar{x} = 0.437$) and MRT ($\bar{x} = 0.435$), which were both significantly higher than the other long-term monitoring sites (HMP & Bonanza; $P < 0.01$) and higher than all but one of the other sites sampled (Table 2).

Regression analyses indicated that number of rosettes, a measure of plant size, was positively correlated with many of the reproductive traits, including number of inflorescences ($r = 0.889$, $P = 0.018$), number of flowers per inflorescence ($r = 0.95$, $P = 0.0036$), number of projected fruits per inflorescence ($r = 0.878$, $P = 0.021$) and per plant ($r = 0.875$, $P = 0.022$), and number of seeds per fruit ($r = 0.958$, $P = 0.0421$). The only two reproductive variables that were not significantly correlated with number of rosettes were fruits per inflorescence and the S/O ratio (Table 2).

Demography and Life History

FECUNDITY AND SURVIVAL.—Sexual reproduction was found to occur at all of the seven size stages (excluding first year seedlings with only two cotyledons and no rosettes), but higher percentages of individuals were reproductive in mid-large size classes (Table 3). Average fecundity for the seven size classes, as estimated by projected contribution to seedlings, ranged from 0.0165 to 0.337 for the southern cluster and 0.0068 to 0.823 for northern cluster (Table 3). Size classes six and seven exhibited the highest average fecundity per individual in the southern and northern clusters, respectively. In both clusters, estimated fecundity per individual plant increased gradually from size class one to size class six. In the northern cluster, this trend continued to size class seven. However, in the south, fecundity dropped again for size class seven (it should be noted that there were few size class seven individuals in the south, so this was a small sample size). However, size class five in the south and size class six in the north were projected to produce the highest total number of seeds/seedlings across all size classes.

Estimated annual survival rates for established plants were fairly high for all size classes (Table 3: specific size class mortality rates, q_x). In the northern cluster, survival rates ranged from 0.83 to 0.97 and from 0.84 to 0.94 in the southern cluster. Regressions between size class and survivorship revealed a strong positive correlation ($r=0.923$, $P=0.003$), suggesting that larger size classes have higher rates of survival. When the two clusters were analyzed separately, this relationship remained significant for the northern cluster ($r=0.93$, $P=0.0024$), but not for the southern cluster.

Overall annual survival rate, as estimated by pooling the data for all size classes, was 0.898 for the south and 0.891 for the north, which are fairly high and comparable. However, some plants were not able to be tracked over all of the years due to lost tags, so mortality rates for these plants were not able to be estimated (S: 4%; N: 14%). If these plants were counted as dead, rather than excluded, mortality rates for the southern cluster would still be fairly high at 0.84, whereas they would be somewhat lower in the north at 0.77.

MATRIX ANALYSES.—The projection matrices (Table 3) estimated finite population rates of increase that were very close to one for both population clusters (S: $\lambda=0.977$; N: $\lambda=1.014$). The southern cluster's was slightly below one, which could indicate that it may be in a state of decline, whereas the northern cluster's finite rate of increase was just slightly above one, which may indicate slightly more stability, but not a period of growth. The projected stable size-class distribution (vector w) was significantly different from the observed population structure for both clusters as well (S: $\chi^2 = 69.70$; N: $\chi^2 = 60.41$). This suggests that the population clusters have not reached a stable population structure or stable stage distribution.

The net reproductive values (R_0 ; Table 4), indicating the number of total offspring produced by an average plant in its lifetime, were fairly different between the two population clusters (N

$R_0 = 1.25$; S $R_0 = 0.71$). The northern cluster had an estimated R_0 value above one ($R_0 = 1.25$), indicating that individuals are expected to be able to produce enough offspring to at least replace themselves over their lifespan. The southern cluster, on the other hand, was estimated to have an R_0 value below one (0.71), suggesting that, on average, individuals may not be able to replace themselves.

Elasticity values (Table 5), which provide standardized estimates of the relative importance of each matrix entry, were compared for demographic processes (fecundity, permanence, growth, and shrinkage) and each of the seven size classes. When elasticities were considered at a demographic process level, permanence and then growth contributed the most to λ in both clusters (around 0.4). However, permanence appeared to be more important than growth in the south. For the north, growth and permanence (stasis) appeared to contribute more equally. Shrinkage contributed less (S: 0.165, N: 0.114) than either permanence or growth, and fecundity contributed the least (S: 0.084, N: 0.065) in both clusters.

The range of summed elasticities by size class was fairly small, in both clusters. Medium to large sized plants (size classes 5 & 6) appeared to be more important to population growth rates than either the very largest or smallest plants. When elasticities were summed for size classes, size class five had the greatest impact on the population growth in the south (0.235) and size class six had the largest influence in the north (0.225).

DISCUSSION

Draba asterophora var. *asterophora* appears to be potentially quite vulnerable, as all long-term monitoring populations in both clusters had fairly low local densities in small populations that are confined to narrow geographic boundaries. In addition, estimated survival rates for adults were fairly high (S: 0.84-0.84; N: 0.83-0.97), while estimated fecundity rates were quite

low (S: 0.0165-0.337); N:0.0068-0.823), suggesting potential difficulty in reestablishment of populations after disturbances.

Alpine communities tend to be sparsely inhabited (Little, 1941). However, even compared to several other alpine and *Draba* species, *D. asterophora* var. *asterophora* was estimated to have fairly low local densities (0.35 to 2.6). Density values were similar to *D. burkei*, (0.279-0.968; Tait 2002). *Draba burkei* is a local Utah endemic, which also inhabits ski runs in the high alpine (Tait, 2002). Density for *D. asterophora* var. *asterophora* were lower compared with *D. trichocarpa*, another rare endemic in Montana, (2.5 to 4.1 plants/m²; Moseley and Mancuso 1993). *Draba asterophora* var. *asterophora* also had lower densities than another more distantly related alpine plant species, *Packera franciscana*, an alpine endemic in Arizona (4.36 ramets per m²; Fowler and Sieg, 2010). *Erigeron mancus*, an alpine endemic in Utah, also was found to have a considerably higher average density of plants (7.09 plants/m²; Fowler & Smith, 2010) than *D. asterophora* var. *asterophora*.

The low local population densities of *D. asterophora* var. *asterophora* may be indicative of the harsh habitats that this species occupies. Low densities of herbaceous plants are suggested to be particularly common in the Sierra Nevadas (densities less than 1 plant/m²; Lloyd and Graumlich 1997). Alpine ecosystems tend to have low accumulation of soil nutrients and water, high wind and water erosion, and more intense UV rays (Benedict 1970), all of which contribute to harsh growing conditions and lead to generally sparse vegetation in such habitats.

The north and south population clusters of *D. asterophora* share many morphological features, including small size, cushion habit, yellow flowers and rosettes with stellate trichomes. However, there was some significant morphological variation among populations and between the two geographic population clusters. The northern population cluster was found to have

somewhat larger, more reproductive individuals than those in the populations of the southern cluster. Specifically, the northern cluster had significantly more rosettes, inflorescences, flowers, fruits, and projected fruits per inflorescence and per plant than those individuals in the southern cluster (Table 1). However, when population clusters were compared reproductively for brood size, the northern and southern clusters were not significantly different. Moreover, the southern cluster actually had a greater ratio of viable seeds per ovule (S/O; Table 1) than the northern population cluster.

One potential explanation for the larger size of plants in the northern versus the southern regions could be micro-climatic and/or microhabitat differences. Climatic diagrams for each of the clusters are given in Fig 4. Due to the higher winter precipitation (snow fall) in the northern region, the habitat may be more conducive to growth. The larger plants in the northern regions might be explained by better environmental growing conditions (e.g. water availability; Wilson 1966; Bliss 1971; Jonas et al. 2008).

Another potential explanation for why the northern cluster had larger plants is that the individuals are tetraploids (Windham 2000), which may provide some polyploid advantages over its diploid relatives in the southern cluster (Ch 3). Polyploids are frequently larger and more robust than their diploid progenitors, including on a cell size level (Gu, Yang, Meng, and Zhang 2005; Parisod, Holderegger, and Brochmann 2010). The larger genomic size can hold more genetic information, allowing for more genetic variation and heterozygosity, both of which can increase fitness (Mahy et al. 2000). Autopolyploids are hypothesized to have increased genome flexibility, which may allow them to adapt and persist in a heterogeneous landscape over the long-term (Parisod, Holderegger, and Brochmann 2010). The potential heterozygous advantage and greater genetic diversity also increase population viability and evolutionary potential

especially in response to disturbances (Allendorf and Luikart 2007). However, this ploidy difference may also help explain the lower S/O found in the north, as autopolyploids may have more difficulty in meiosis (e.g. pollen abortion, Ch. 3) and/or experience inbreeding depression (Ozimec and Husband 2010). Morphological variation between the clusters may also be the consequence genetic differences from genetic drift due to isolation by distance (Wright 1931).

Regarding *D. asterophora*'s life history characteristics, both population clusters appear to be fairly stable, but not growing. In addition, the northern population cluster's calculated lambda, or the finite rate of increase, was slightly above one, whereas the southern population cluster's lambda was slightly below one (Table 3). This may possibly indicate that the northern cluster is more stable than the southern. Thus the southern cluster may be at more of a risk for population decline. However, neither cluster has reached a stable stage distribution, suggesting they may be experiencing some year to year fluctuation, which tends to increase vulnerability for rare plants (Rabinowitz et al. 1989; Dickenson et al. 2007; Marcante et al. 2009).

The net reproductive rate (R_0), which is indicative of whether average individuals can be expected to replace themselves or not during their lifespan, was higher in the north (>1) than the south population cluster (<1 ; Table 4). This suggests that, on average, individuals in the north will be more likely would be able to replace themselves than in the south. The net reproductive was below unity in the south, which suggests an increased risk that individuals may not be able to replace themselves. Inability of replacement would be detrimental to the long-term survival of the populations in the south.

The same potential explanations that may contribute to greater morphological robustness in the north than south may also play a role in the differences in life history vital rates between the two clusters. These include general microclimatic differences (Carter and Prince 1988; Buckley

and Kingsolver 2012; Wieser 2010), specific site microhabitat differences (Urbanska, 1997; Litaor et al. 2004; Harper et al. 1961; Harper, Williams and Sagar, 1965), polyploidy advantage in the north (Gu, Yang, Meng, and Zhang 2005; Allendorf and Luikart 2007; Parisod, Holdregger, and Brochmann 2010; and genetic drift (Wright 1931).

In comparison with another rare endemic *Draba*, *D. asterophora* var. *asterophora* in both regions had higher finite rates of increase (S: $\lambda=0.977$; N: $\lambda=1.014$) than *D. trichocarpa*, for ($\lambda = 0.897$; Moseley and Mancuso 1993). We found fairly comparable rates to other alpine species, which had lambdas around one (0.824-1.15), particularly those in at late successional stages (Marcante, Winkler, Erschbamer 2009).

We also found fairly high survival rates but very low recruitment rates and fecundity for *D. asterophora* var. *asterophora*. This finding is fairly consistent with other *Draba* species (Tait 2002; Moseley and Mancuso 1993) and other rare and alpine species (Marcante et al. 2009). For example, *Draba asterophora* var. *asterophora* also had similar survival rates as another *Draba* species, *D. burkei* (0.871-.0945; Tait 2002).

Alpine species appear to have unique demographic strategies, with many species across the successional gradient relying primarily on survival of adult individuals and fecundity being only of minor importance (Marcante et al. 2009). *Draba asterophora* var. *asterophora* follows this pattern with fairly high adult survival but very low fecundities. In addition, Marcante et al. (2009) speculated that this tendency for alpine species to act like late succession or climax species with high survival rates helps to buffer populations against temporal variation in these harsh environments.

In comparing *D. asterophora*'s fecundity to other herbaceous perennials and other *Draba* species in particular, both pre-emergent (viable seed production) and post-emergent (germination

and survival) factors should be considered (Wiens et al. 1987). *Draba asterophora*'s seed to ovule ratios (0.28-0.54) were only a little lower than the average of other herbaceous perennials ($\bar{x} = 0.572$; Wiens 1984). However, *D. asterophora*'s brood sizes (2.44-3.45) were much lower than those found for other herbaceous perennials ($\bar{x} = 13.5$; Wiens 1984), but fairly consistent with another rare *Draba* (*D. trichocarpa*: 1.9-2.6; Moseley and Mancuso 1993). Wiens (1984) also noted that perennials tended to engage in much more outcrossing than annuals, which are normally self-pollinating. Perennials also were found to have significantly smaller brood sizes than annuals (Wiens 1984). *Draba asterophora* appears to follow this trend, having better seed set when out-crossing, although it is not completely self-incompatible. In addition, Wiens (1984) and Wiens et al. (1987) suggest that differences in seed sets among species are due to genetic factors rather than environmental factors.

Similar to *D. asterophora* var. *asterophora*, *D. trichocarpa* was also found to have poor seedling recruitment (Moseley and Mancuso 1993). Together with high seedling mortality, poor recruitment was the greatest contributors to the population decline and was a major bottleneck for *D. trichocarpa* (Moseley and Mancuso 1993). They noted that seedling recruitment and survival is largely vulnerable to environmental conditions, such as spring rain, and that populations may not need good recruitment each year as long as there are infrequent good years (Moseley and Mancuso 1993). Thus, a longer-term study of *D. asterophora* var. *asterophora* may be useful to better measure any potential fluctuations in recruitment. However, reliance of seedlings on good environmental conditions would also not bode well for *Draba* species in general in light of changing, particularly warmer and drier, environmental conditions in the alpine regions due to global climate change, as "good" years for seedlings are likely to become even less frequent.

Rare, endemic alpine species, in particular, exemplify this trend of having high longevity and high survival rates of adult individuals (Dickenson et al. 2007), especially when compared to more common species. Lower seed sets are also characteristic of rare species with narrow geographical ranges (Murray et. al, 2002). This pattern of low seed production was the only consistent finding among studies comparing rare and common species (Murray et al., 2002). For example, *Erigeron kachinensis* is one such rare species that had low seed set due to low fertilization of ovules (~48%) and high abortion rates (~56%) as a out-crossing perennial (Allphin, Wiens, and Harper, 2002). *Draba asterophora* also had fairly high abortion rates in at least some of the populations (those with lower S/O ratios; i.e. S/O= 0.2).

Within populations, there tends to be variation among individuals for survivorship and fecundity. Survivorship and fecundity are typically more related to size than age (Moseley and Mancuso 1993; Caswell 2001; Dickenson et al. 2007). In alpine systems, older and larger individuals also tend to have both higher survival rates and higher flowering rates (Dickenson et al. 2007). In *Draba asterophora* var. *asterophora* populations the larger plants also tended to have higher survival rates and greater fecundity in general (S: 6, N: 7; Table 3). In addition, *D. asterophora* var. *asterophora*'s mid-larger size classes had the highest total contribution to the seed bank (S: 5, N: 6). Likewise, size tended to be a better predictor of demographic performance for the rare *D. trichocarpa* (Moseley and Mancuso 1993).

While most demographic studies on specific alpine species have found high survival of adults and low seedling recruitment, one study specifically investigating alpine seedling demography, found high densities of seedlings, particularly in wetter habitats (Forbis 2003). This wetter habitat may be more reflective of alpine meadows, rather than an alpine rock field, which he distinguished as having a much less dense flora and occupies a more unstable and less

weathered substrate (Little 1941). Forbis (2003) also found the highest rates of mortality for seedlings in the seedlings' first year and then decreased in subsequent years, which is fairly consistent with other demographic studies of alpine species.

Additionally, the placement of an individual in a population or the species range may also affect fecundity (Dickenson et al. 2007; Vaupel and Matthies 2012). Individuals near patch edges tend to have a lower probability flowering (Dickenson et al. 2007). In contrast, individuals in populations near the species range limits produced fewer viable seeds, primarily due to increased abortion, despite having larger plants on average (Vaupel and Matthies 2012). This may also apply to the differences in site viable seed to ovule ratios observed in *D. asterophora* var. *asterophora*.

Implications for Conservation and Management of *Draba asterophora* var. *asterophora*

Currently, both population clusters of *D. asterophora* var. *asterophora* appear to be fairly stable in the absence of disturbance. Because long-term population persistence is reliant on survival and growth of established adults, these populations would likely not be able to recover from any future impacts. Potential for recovery would also be impacted by the taxon's low local population densities and low fecundities, Mid to large individuals are particularly important to the long-term persistence of the populations as well as contributed the most to recruitment and had highest fecundities, as well as survivorship. If adult plants, especially large ones, are lost, reestablishment of populations would be unlikely. The southern population is of particular concern regarding recruitment as its net reproductive value was under one, but both clusters demonstrated low local density and low fecundities. Therefore, it is crucial that established adults in their intact microhabitats of stable populations be maintained and preserved. Any direct negative impacts to *D. asterophora* var. *asterophora* must be avoided.

Although areas which were directly impacted by the grading were not included in this study, the impacts after several years were still visually obvious. Only a handful of plants in the Bonanza grading area have persisted after several years, demonstrating the apparent difficulty in reestablishment of the population either through transplantation or natural seed migration (Elizabeth Bergstrom, USFS, personal communication). This supports this finding that population persistence appears to rely more on established individuals than recruitment and that direct destruction of individuals is detrimental to the population.

In addition, specific microhabitat characteristics may also play a significant role. Established populations often had large boulders with several *D. asterophora* var. *asterophora* plants growing underneath. This suggests that these large boulders may act as a natural refuge, providing protection from harsh winds and/or increased water availability due to shade or pockets of water accumulation in the summer. Therefore, protection of both established individuals and their intact habitat are likely both important for the long-term survival of these population clusters. This is especially true to areas vulnerable to human impacts.

Thus, it is important that management plans for alpine species like *D. asterophora* var. *asterophora* focus on maintenance of existing adult individuals within populations rather than expecting new recruits to replace lost individuals after disturbance.

LITERATURE CITED

- ALLENDORF, F. W. AND G. LUIKERT. 2007. Conservation and the Genetics of Populations. Blackwell Publishing: Malden, MA, USA.
- ALLPHIN, L., WIENS, D. AND K.T. HARPER. 2002. The relative effects of resources and genetics on reproductive success in the rare kachina daisy, *Erigeron kachinensis* (Asteraceae). International Journal of Plant Sciences 163:599-612.
- BASKIN, J.M AND C.C. BASKIN. 1986. Some considerations in evaluating and monitoring populations of rare plants in successional environments. Natural Areas Journal 6:26-30.
- BENEDICT, J.B. 1970. Downslope soil movement in a Colorado alpine region: rates, processes, and climatic significance. Arctic and Alpine Research 2(3):165-226.
- BEVILL, R.L. AND S.M. LOUDA. 1999. Comparisons of related rare and common species in the study of plant rarity. Conservation Biology 13(3):493-498.
- BLISS, L.C. 1971. Arctic and alpine plant life cycles. Annual Review of Ecology and Systematics 2:405-438.
- BUCKLEY, L.B. AND J.B. KINGSOLVER. 2012. The demographic impacts of shifts in climate means and extremes on alpine butterflies. Functional Ecology 26(4):969-977.
- CALIFORNIA NATIVE PLANT SOCIETY (CNPS). 2012. Inventory of Rare and Endangered Plants (online edition, v8-01a). California Native Plant Society. Sacramento, CA. Accessed on Tuesday, August 28, 2012.
- CALLAGHAN, T.V., S. JONASSON, H. NICHOLS, R.B. HEYWOOD, AND P.A. WOOKEY. 1995. Arctic terrestrial ecosystems and environmental change [and discussion]. Philosophical Transactions of the Royal Society A: Mathematical, Physical and Engineering Sciences 352(1699):259-276.

- CARTER, R.N. AND S.D. PRINCE. 1988. Distribution limits from a demographic viewpoint. In Plant Population Ecology (eds A.J. Davey, M.J. Hutchings, and A.R. Watkinson) pp. 165-84.
- CASWELL, H. 2001. Matrix population models: 2nd Edition. Sinauer: Sunderland, MA.
- COTTAM, G. AND J.T. CURTIS. 1956. The use of distance measures in phytosociological sampling? Ecology 37:451-460.
- DAVIS, M. B. AND R.G. SHAW. 2001. Range shifts and adaptive responses to quaternary climate change. Science 262.
- DE KROON, H. A., J.M. VAN GROENDAEL, AND H. CASWELL. 1986. Elasticity: the relative contribution of demographic parameters to population growth rate. Ecology 67:1427–1431.
- DICKENSON, K.J.M., KELLY, D., MARK, A.F., WELLS, G., AND R. CLAYTON. 2007. What limits a rare alpine plant species? Comparative demography of three endemic species of *Myosotis* (Boraginaceae). Austral Ecology 32: 155-168.
- DIGGLE, P.J. 1975. Robust density estimation using distance methods. Biometrika 62:39–48.
- EGERTON, J.J.G. AND S.D. WILSON. 1993. Plant competition over winter in alpine shrubland and grassland, Snowy Mountains, Australia. Arctic and Alpine Research 25 (2): 124-129.
- FALK, D.A. AND K.E. HOLSINGER. 1991. Genetics and Conservation of Rare Plants. Oxford University Press: New York.
- FIEDLER, P.L., B.E. KNAPP, AND N. FREDERICKS. 1998. Rare plant demography: lessons from the mariposa lilies. Pp. 28-48 in P.L. Fielder and P.M. Kareiva (eds.), Conservation Biology: For the Coming Decade. Chapman and Hall: New York.
- FORBIS, T.A. 2003. Seedling demography in an alpine ecosystem. American Journal of Botany 90(8):1197-1206.

- FOWLER, J. F. AND B. SMITH. 2010. *Erigeron mancus* (Asteraceae) density as a baseline to detect future climate change in La Sal Mountain habitats. Journal of Botany Research Institute of Texas 4:747-753.
- FOWLER, J.F. AND C.H. SIEG. 2010. Density and elevational distribution of the San Francisco peaks ragwort, *Packera franciscana* (Asteraceae), a threatened single-mountain endemic. Madroño 57(4):213-219.
- Gabrielová, J., Z. Münzbergová, O. Tackenberg, and J. Chrtek. 2013. Can we distinguish plant species that are rare and endangered from other plants using their biological traits? Folia Geobot 48(3). DOI 10.1007/s12224-012-9145-x
- GODÍNEZ-ALVAREZ, H. AND JORDANO, P. 2007. An empirical approach to analyzing the demographic consequences of seed dispersal by frugivores. In: Seed Dispersal: Theory and its Application in a Changing World. (eds A.J. Dennis et al.)
- GU, X.F., A.F. YANG, H. MENG, J.R. ZHANG. 2005. In vitro induction of tetraploid plants from diploid *Zizyphus jujube* Mill. Cv. Zhanhua. Plant Cell Reproduction 24:671-676.
- GUISAN, A. AND J.-P. THEURILLAT. 2000. Assessing alpine plant vulnerability to climate change: a modeling perspective. Integrated Assessment 1:307-320.
- GUISAN, A., & THEURILLAT, J. P. 2001. Equilibrium modeling of alpine plant distribution: how far can we go? Phytocoenologia 31(1):147-148.
- HARPER J.L., J.N. CLATWORTHY, I.N. MCNAUGHTON AND G.R. SAGAR. 1961. The evolution and ecology of closely related species living in the same area. Evolution 15(2):209-227.
- HARPER, J.L., J.T. WILLIAMS, AND G.R. SAGAR. The behavior of seeds in soil: I. The heterogeneity of soil surfaces and its role in determining the establishment of plants from seed. Journal of Ecology 53(2):273-286.

- HICKMAN, J.C. (ED.). 1993. The Jepson Manual. University of California Press, Berkeley, CA.
- HOOD, G.M. 2010. PopTools version 3.2.5. Available on the internet. URL
<http://www.poptools.org>
- HUGHES, L. 2002. Indicators of climate change. Climate change impacts on biodiversity in Australia. (Eds M. Howden, L. Hughes, M. Dunlop, I. Zethoven, D. Hilbert, C. Chilcott) pp, 58-62.
- JBR ENVIRONMENTAL CONSULTANTS, INC. 2004. Mt. Rose Ski Tahoe 2004 Sensitive Species Management Report. Prepared for Mt. Rose Ski Tahoe, Contact Paul Senft. On File Carson Ranger District, Humboldt-Toiyabe N.F. 5pgs.
- JMP PRO 9. SAS Institute Inc., Cary, NC, 1989-2007.
- JONAS, T., C. RIXEN, M. STURM, V. STOECKLI. 2008. How alpine plant growth is linked to snow cover and climate variability. Journal of geophysical research 113(G3)
- KOPP, C.W. AND E.E. CLELAND. 2013. Shifts in plant species elevational range limits and abundances observed over nearly five decades in western North America mountain range. Journal of Vegetation Science 25(1):135-146.
- KREBS, C.J. 1999. Ecological Methodology (2nd Ed). Menlo Park, CA: Benjamin/Cummings.
- LITAOR, M.I., T.R. SEASTEDT, M.D. WALKER, M. CARBONE, AND A. TOWNSEND. 2005. The biogeochemistry of phosphorus across an alpine topographic/snow gradient. Geoderma 124:49-61
- LITTLE, E., L. JR. (1941). Alpine flora of San Francisco Mountain, Az. Madrono. 6:65-81.
- LLOYD, A.H. AND L.J. GRAUMLICH. 1997. Holocene dynamics of treeline forests in the Sierra Nevada. Ecology 78:1199-1210.
- MAHY, G., L.P. BRUEDERLE, B. CONNORS, M. VAN HOFWEGEN, AND N. VORSA. 2000. Allozyme

- evidence for genetic autopolyploidy and high genetic diversity in tetraploid cranberry, *Vaccinium oxycoccos* (Ericaceae). *American Journal of Botany* 87:1882–1889.
- MARCANTE, S., E. WINKLER, AND B. ERSCHBAMER. 2009. Population dynamics along a primary succession gradient: do alpine species fit into demographic succession theory? *Annals of Botany* 103(7):1129-1143.
- MILLS, L.S. 2012. *Conservation of Wildlife Populations: Demography, Genetics, and Management* (2nd Ed). Missoula, MT: Wiley-Blackwell.
- MITCHELL, K. 2007. Quantitative analysis by the point-centered quarter method. <http://arxiv.org/pdf/1010.3303.pdf>
- MOSELEY, R.K. AND M. MANCUSO. 1993. Demographic monitoring of two Stanley Basin endemics, *Draba trichocarpa* and *Eriogonum meledonum*. III. Third year results. Idaho Department of Fish and Game. Conservation Data Center: Boise, ID.
- MURRAY, B.R., P.H. THRALL, A.M. GILL, AND A.B. NICOTRA. 2002. How plant life-history and ecological traits relate to species rarity and commonness at varying spatial scales. *Austral Ecology* 27(3):291-310.
- NEVADA NATIVE PLANT SOCIETY (NNPS) STATUS LISTS. 2010. <http://heritage.nv.gov/lists/nnps1004.pdf>
- OZIMEC, B. and B.C. Husband. 2011. Effect of recurrent selfing on inbreeding depression and mating system evolution in an autopolyploid plant. *Evolution* 65(7):2038-2049.
- PARISOD, C. R. HOLDEREGGER, C. BROCHMANN. 2010. Evolutionary consequences of Polyploidy. *New Phytologist* 186(1):5-17.
- PAULI, H. M. GOTTFRIED, AND G. GRABHERR. 1996. Effects of climate change on mountain ecosystems – upward shifting of alpine plants. *World Resource Review* 8(3):382-390.

- PEARSON, K. 1900. On the criterion that a given system of deviations from the probable in the case of a correlated system of variables is such that it can be reasonable supposed to have arisen from random sampling. *Philosophical Magazine Series 5* 50(302):157-175.
- RABINOWITZ, D., J.K. RAPP, S. CAIRNS, AND M. MAYER. 1989. The persistence of rare prairie species in Missouri: environmental variation buffered by reproductive output of sparse species. *American Naturalist* 134:525-544.
- ROMME, W.H. AND M.G. TURNER. 1991. Implications of global climatic change for biogeographic patterns in the Greater Yellowstone Ecosystem. *Conservation Biology* 5:373-386.
- SIMBERLOFF, D. 1988. The contribution of population and community biology to conservation science. *Annual Review of Ecology and Systematics* 19:473-511.
- TAIT, D. 2002. Ecological and reproductive diversity within and among populations of *Draba burkei* sp. nov. in northern Utah. Masters Thesis, Brigham Young University.
- URBANSKA, K.M. 1997. Restoration ecology research above the timberline: colonization of safety islands on a machine-graded alpine ski run. *Biodiversity and Conservation* 6:1655-1670.
- VAUPEL, A. AND D. MATHIES. 2012. Abundance, reproduction, and seed production of an alpine plant decrease from the center toward the range limit. *Ecology* 93:2253-2262.
- WALTER, K.S. AND H.J. GILLET (EDS). 1997 IUCN Red List of Threatened Plants. 1998. Compiled by the World Conservation Monitoring Centre. IUCN – The World Conservation Union, Gland, Switzerland and Cambridge, UK. 822pp.
- WIENS, D. 1984. Ovule survivorship, brood size, life history, breeding systems, and reproductive plants. *Oecologia* 64:47-53.

WIENS, D., CALVIN, C.L., WILSON, C.A., DAVERN, C.I, FRANK, D., AND S.R. SEVEY. 1987.

Reproductive success, spontaneous embryo abortion and genetic load in flowering plants.

Oecologia 71:501-509.

WIESER, G. 2010. Lessons from the timberline ecotone in the Central Tyrolean Alps: a review.

Plant Ecology and Diversity 5(1): 127-139.

WILSON, J.W. 1966. An analysis of plant growth and its control in arctic environments. Annals of

Botany 30(3):383-402.

WRIGHT, S. Evolution in Mendelian populations. Genetics 16(3):290.

TABLES AND FIGURES

TABLE 1. Density estimates (plants per m²) of *D. asterophora* var. *asterophora*. Based on Diggle's (1975) method of combining results from the point-quarter and nearest-neighbor methods utilizing post-data acquisition cut-offs with a correction factor (Mitchell, 2007) for subsequent missing data.

	Southeast Region (SE)			Northeast Region (NE)		
	Freel	HEP	HMP	MRT	Bonanz a	Bruce
Diggle's year 1	2.98	0.398	0.437	1.265	0.869	0.73
Diggle's year 2	2.27	0.51	0.27	1.06	1.12	0.39
Average Diggle's	2.6	0.454	0.354	1.163	0.995	0.56

Note. Year one was 2005 for most sites, except Freel, where data was collected in 2006 (when its long-term monitoring was first set up) and year two was 2007 for all sites.

TABLE 2. Vegetative and reproductive plant characteristics for *Draba asterophora* var. *asterophora* by site. Different letters in a row indicate statistically significant differences ($P \leq 0.05$)

	<i>D. asterophora</i> var. <i>asterophora</i> (Southern)				<i>D. asterophora</i> var. <i>asterophora</i> (Northern)			
	Remote		Ski Resort		Remote		Ski Resort	
	Freel	HEP	HMP	Southern cluster ave.	MRT	Bonanza	Bruce	Northern cluster ave.
# Tagged Plants	28	76	76		60	84	102	
Mean # Rosettes	7.21 b	15.66 ab	8.98 b	11.52	14.79 ab	12.03b	21.94a	16.72*
% Flowering Plants	69.23 bc	39.68 a	55.83 b	49.72	59.69bc	66.02 c	65.87 c	64.32*
Mean # Inflorescences per plant	3.13 b	4.08 b	3.97 b	3.85	6.05 b	4.61 b	10.26 a	7.3*
Mean # Flowers/ Inflorescence ^d	5.24 a	5.94 ab	5.32 a	5.45	6.16 ab	6.12 ab	7.38 b	6.75*
Mean # Fruits/ Inflorescence ^e	6.33 ab	6.08 a	5.42 a	5.74	6.70 a	5.28 a	8.40 b	6.99*
Mean projected Fruits/ Inflorescence ^f	5.06 b	5.28 b	5.08 b	5.15	6.19 b	5.24 b	7.73 a	6.51*
Mean # projected Total Fruits/ Plant ^f	16.27 b	22.66 b	22.94 b	21.57	43.82 b	28.88 b	81.32 a	54.54*
Mean brood Size	--	--	2.44 a	2.60	3.06 b	2.84 ab	3.36 b	2.73
Mean # Seeds/Ovule ^g	--	--	0.36 b	0.387*	0.44 c	0.28 a	0.43 c	0.346

All morphological data was averaged across years for tagged individuals prior to statistical analysis.

^dThe mean flowers per inflorescence were calculated only from plants solely in flower when sampled (June/July), not from plants with both flowers and fruits simultaneously.

^eThe mean fruits per inflorescence are only from plants solely in fruit when sampled (July/August).

^fThe mean projected total fruits per plant data incorporates data from all plants, using a factor of 0.64 to project fruits for buds and flowers.

^gFruits were too immature at times of collection for the Freel and HEP sites to collect data regarding viable seeds for these sites.

*Indicates significant difference ($P < 0.05$) between the southern and northern region.

TABLE 3. Population projection matrices and main demographic results for the *Draba asterophora* var. *asterophora* populations that were chosen for long-term monitoring for years 2005-2008 (data pooled). The corresponding λ value is shown in the footnote, q_x = mortality per size class, w = projected stable stage class distribution, v =reproductive values per stage class, n_x = total plants sampled per size class from which transition probabilities were calculated..

a. Southeast population cluster

	Seedlings	1	2	3	4	5	6	7	w	v	n_x
Projected											
Seedlings	0.000	0.016	0.036	0.047	0.092	0.207	0.337	0.115	9.3%	7.7%	
1	0.840	0.240	0.068	0.034	0.029	0.009	0.000	0.000	13.9%	9.0%	25
2	0.000	0.320	0.443	0.224	0.057	0.037	0.020	0.000	18.3%	10.0%	89
3	0.000	0.160	0.227	0.397	0.143	0.028	0.020	0.000	16.0%	10.9%	58
4	0.000	0.080	0.114	0.207	0.329	0.187	0.060	0.000	16.0%	11.8%	70
5	0.000	0.040	0.045	0.069	0.243	0.561	0.220	0.143	18.9%	14.3%	107
6	0.000	0.000	0.000	0.000	0.043	0.065	0.500	0.286	5.3%	18.8%	50
7	0.000	0.000	0.000	0.000	0.014	0.009	0.120	0.500	2.2%	17.4%	14
q_x		0.160	0.102	0.069	0.143	0.103	0.060	0.071			

$\lambda=0.977$

b. Northeast population cluster

	Seedlings	1	2	3	4	5	6	7	w	v	n_x
Projected											
Seedlings	0.000	0.007	0.024	0.039	0.105	0.138	0.388	0.823	13.44%	5.46%	
1	0.830	0.229	0.093	0.000	0.036	0.007	0.000	0.000	16.28%	6.67%	48
2	0.000	0.354	0.320	0.061	0.036	0.046	0.013	0.000	11.33%	7.35%	75
3	0.000	0.167	0.253	0.273	0.084	0.046	0.013	0.000	10.29%	9.83%	66
4	0.000	0.063	0.107	0.318	0.373	0.099	0.013	0.027	11.98%	11.05%	83
5	0.000	0.021	0.053	0.197	0.349	0.467	0.213	0.108	19.03%	12.75%	152
6	0.000	0.000	0.000	0.030	0.036	0.217	0.563	0.189	12.83%	19.75%	80
7	0.000	0.000	0.000	0.000	0.000	0.000	0.138	0.649	4.83%	27.14%	37
q_x		0.167	0.173	0.121	0.084	0.118	0.050	0.027			

$\lambda=1.01$

TABLE 4. Vital rates of growth and reproduction as calculated based on population projection matrices of *Draba asterophora* var. *asterophora*.

	Southern	Northern
Lambda (λ) –finite rate of population change	.977	1.014
R ₀ – net reproductive rate	.710	1.25
T – generation time	14.60	16.12

TABLE 5. Elasticities per demographic process (a) and size class (b) corresponding to the projection matrices for *Draba asterophora* var. *asterophora*.

a. Demographic		
Process	Southern	Northern
Permanence	0.412	0.411
Growth	0.361	0.410
Shrinkage	0.165	0.114
Fecundity	0.062	0.065
b. Size Class		
	SE	NE
1	0.108	0.0965
2	0.159	0.074
3	0.152	0.090
4	0.163	0.118
5	0.235	0.215
6	0.087	0.225
7	0.033	0.116



Fig. 1. Map of study area (Photo credit: google maps; <http://maps.google.com>)

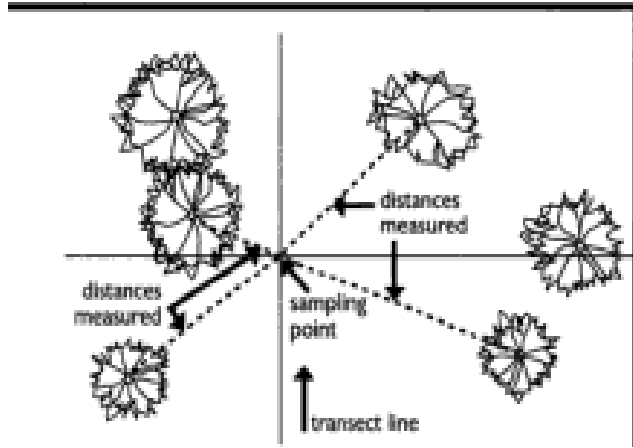
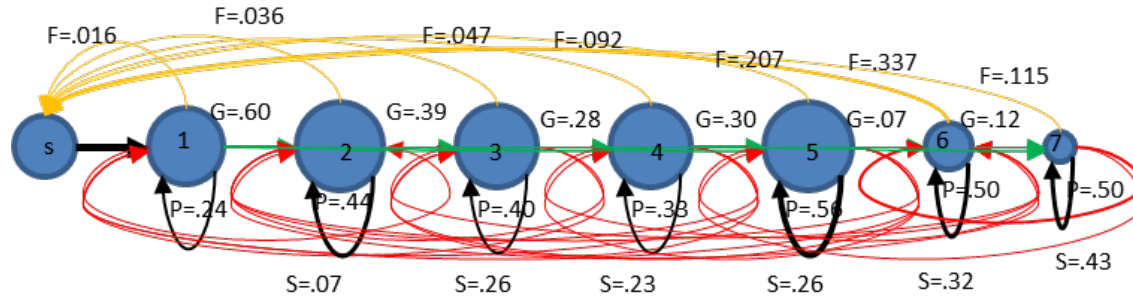
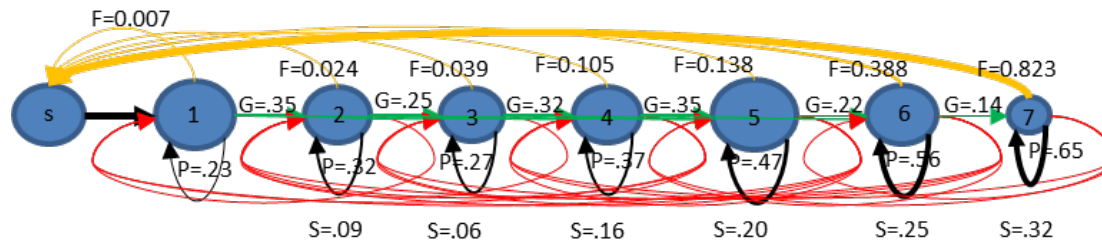

Fig. 2. Point-Quarter Method Diagram (Cottam and Curtis, 1956)



a. Southeast population cluster life-cycle graph



b. Northeast population cluster life-cycle graph

Fig. 3. Life-cycle graph for the populations of *Draba asterophora* var. *asterophora* that were studied through long-term monitoring.

a) Southeast (SE) cluster of Lake Tahoe (including two sites in Heavenly Ski Resort and Freel Mt. outside of the ski resort)

b) Northeast (NE) cluster of Lake Tahoe (including two sites in Mt. Rose Ski Resort and Mt. Rose Mt. outside of the ski resort).

Nodes represent the stage classes (projected seedlings and 7 observed size classes); the relative size corresponds to the stage structure of the population cluster.

The arrows and associated values represent the transition probabilities or contributions to specific stages. F= fecundity (yellow), P=permanence (black),

G=growth (green, growth to any larger class), S=shrinkage (red, proportion shrinking to all smaller stage classes).

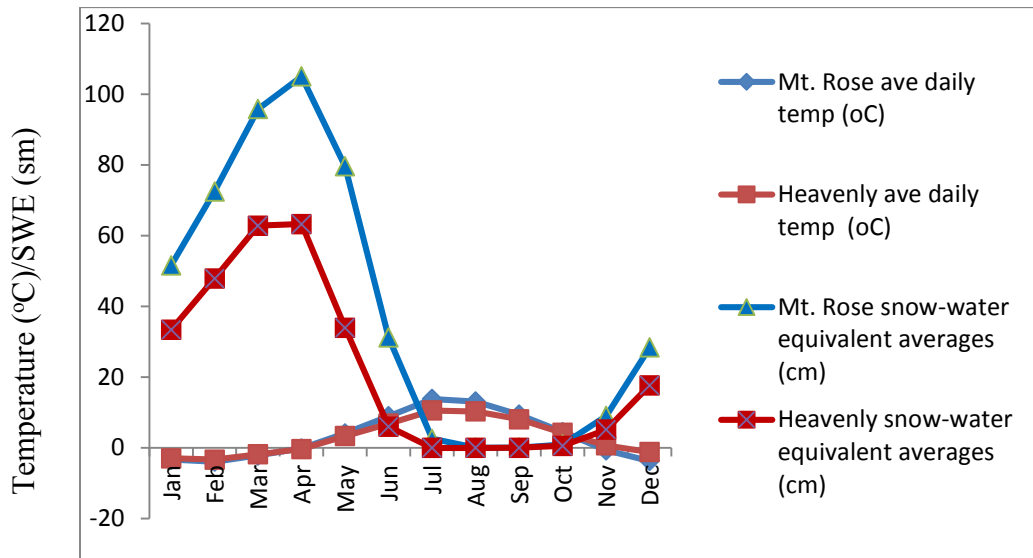

Fig. 4. Climatic Diagram: Monthly average temperatures and precipitation at Mt. Rose Ski Resort (north) and Heavenly Ski Resort (south). SWE=snow water equivalent.

CH 2: HABITAT CHARACTERISTICS OF THE RARE AND ENDEMIC

DRABA ASTEROPHORA (TAHOE STAR DRABA)

ABSTRACT

Habitat destruction and alteration, through both direct human impacts and indirect effects such as climate change, threaten many rare species. Harsh alpine environments are particularly vulnerable to climate change and human impacts such as ski resort development and snowmaking. *Draba asterophora* is one rare, alpine species currently threatened by ski resort. This study examined the habitat requirements of *D. asterophora* by characterizing the abiotic habitat (soil chemical and texture analysis and site features such as aspect, slope, elevation) and the vegetative communities at *D. asterophora* populations. In addition, we generated predictive models regarding *D. asterophora* growth and biotic community characteristics. *Draba asterophora* populations share fairly similar abiotic and biotic habitats despite large geographical separation. *Draba asterophora* habitats consist of steep, rocky slopes in the subalpine conifer zone with little understory. *Draba asterophora* cover and frequency were found to be significantly related to several abiotic (i.e. pH, P, K) and biotic (species richness, biotic cover) variables. *Draba asterophora*'s (cover and frequency) was positively correlated with species richness, but negatively correlated with total vegetative cover (relative cover), suggesting that *D. asterophora* may be more frequent and dominant in communities with greater diversity but lower total biotic cover. In addition, *D. asterophora* had greater seed production (both seed/ovule ratio and brood size) in areas with greater species diversity. *Draba asterophora* does not appear to have many specific soil textural requirements or specific mutualistic or avoidant interspecific associations. However, *D. asterophora* generally exhibits greater cover and frequency in diverse communities, albeit somewhat sparsely populated, in relatively open north-facing alpine habitats on steep granitic slopes. Safe sites and micro-topography within the larger habitat also appear to be important to *D. asterophora*'s establishment and persistence. Changes in landscape and/or snow cover, due to disturbances such as grading, erosion, or snowmaking, may be detrimental to *D. asterophora* by rendering its habitat unsuitable. Overall, the taxon's alpine environment is a fragile and vulnerable ecosystem threatened by ski run expansion. Therefore, *D. asterophora* should be protected from further human impacts. In addition, diversity should be maintained in alpine areas for the benefit of both *D. asterophora*, as well as its associated vegetative community.

Draba asterophora Payson, commonly known as the Tahoe Star Draba, is a rare (sub)alpine, perennial endemic known only from three regions of the Sierra Nevada Mountains surrounding Lake Tahoe (Fig.1). Currently, there are two recognized varieties of *Draba asterophora*: var. *asterophora* (Payson) and var. *macrocarpa* (C.L. Hitchc.). Population clusters to the north and south of Lake Tahoe are presently designated as variety *asterophora* while the cluster to the southwest is assigned to the variety *macrocarpa* (Rollins 1993).

Draba asterophora is listed in California Native Plant Society's (CNPS) Inventory of Rare and Endangered Plants as 1B.2, indicating that it is considered rare, threatened or endangered throughout its range (CNPS 2012). It is also listed as a threatened species on the Nevada sensitive species list (Nevada Native Plant Society, NNPS, Status Lists 2010). It is considered a vulnerable (corresponds to TNC category G2T2) species globally, indicating that it is likely to move into endangered if current causal factors continue (1997 IUCN Red List of threatened plants; Walter and Gillett 1998).

Draba asterophora is restricted to a narrow range of (sub)alpine habitats (2500 – 3400m elevation). It typically occurs on fairly steep west to north facing granitic slopes on high mountain peaks. Its habitat is sparsely vegetated (Hickman 1993; Engelhardt and Gross 2011; Al-Shehbaz 2012).

Much of the habitat in the northern and southern regions of *D. asterophora* var. *asterophora* is located on ski resort properties that face potential threats from ski run expansion and alterations. Although initial clearing of trees (in 1950s) for ski run may have opened more habitats for *D. asterophora* var. *asterophora*, more recent activities have been more detrimental. One impact occurred in 2004 when one of the ski runs was graded (Bonanza) in Mt. Rose Ski Resort destroying an estimated 26,000 individual plants (JBR Environmental Consultants, Inc.

2004) and altering the habitat substantially. Remediation efforts of transplantation have been largely unsuccessful. Other ski run and property modifications have been made and more are proposed on both private and U.S. Forest Service lands containing *D. asterophora* habitat (Bergstrom, Personal Communication; Engelhardt and Gross 2011). In addition, indirect impacts, including erosion from alterations in areas surrounding the *D. asterophora* populations, have also negatively affected this species complex. Some of the human impacts of concern other than related to construction and maintenance of ski resort facilities in the area include hiking, equestrian use, trail construction, snowmobiles (Engelhardt and Gross 2011).

These types of human alterations of the habitat can have dramatic impacts on plant communities in alpine regions (Price, 1985). For example, ski resorts may contribute to loss of species diversity in alpine regions (Ursbanka, 1997). Habitat loss for *D. asterophora* as a result of direct and indirect human activities in its alpine communities may result overall biodiversity loss and extinctions (Wilson 1985, 1993, 1999). Thus, species, such as *D. asterophora*, are particularly vulnerable in the face of habitat loss and alteration.

Besides the direct and indirect impacts of human activity, global climate change may also affect the abiotic aspects and vegetative communities of *D. asterophora*. Global warming may cause *D. asterophora's* habitats to become less stable and increasingly unpredictable by contributing to altered abiotic conditions (including temperature, water availability, length of growing season) and increased climatic fluctuations. Alpine plant species may also face encroachment and competition as lower elevation species move further up mountain peaks in response to changing conditions (Guisan and Theurillat 2000, 2001; Theurillat and Guisan 2001; Walther, Beißner, Burga 2009; Fordham et al. 2012). Factors, such as an uninhabitable matrix between acceptable habitats, can also prevent migration between mountain peaks (Davis and

Shaw 2001). Therefore, rare endemic alpine plant species, like *D. asterophora*, are also particularly vulnerable to extinction in the face of global climate change.

Due to these potential habitat threats, the US Forest Service has been mandated to develop an appropriate, individualized management plan for *D. asterophora*'s conservation. However, little information is known regarding the species habitat requirements and community characteristics. In order for the US Forest Service to develop such a management plan for *D. asaterophora*, a better understanding of what represents the critical habitat for this taxon is needed. Therefore, understanding both the abiotic habitat and vegetative communities of *D. asterophora* is necessary for the taxon's conservation. This information would also contribute to the growing literature on the habitats occupied by rare alpine species. Specifically our objectives were to:

- 1) CHARACTERIZE ABIOTIC HABITAT.—We wanted to characterize the abiotic habitat of *Draba asterophora*, by taking measurements of site characteristics including: aspect, elevation, and percent slope. We also wanted to characterize the soil at each population including parameters such as: soil texture, pH, conductivity and soil chemistry.
- 2) CHARACTERIZE VEGETATIVE COMMUNITY.—We wanted to characterize vegetative communities associated with *Draba asterophora*, by estimating vegetative cover, species richness, diversity, as well as total and relative cover and frequency of prominent species in the community.
- 3) CREATE REGRESSION MODELS FOR PREDICTION OF ESSENTIAL HABITAT ELEMENTS.—We wanted to utilize regression analyses to determine best predictive models for *Draba asterophora* frequency and cover as well as total vegetative cover in the community.

METHODS

Study Area

DRABA ASTEROPHORA HABITAT.—*Draba asterophora*, occurs in three population clusters (Fig. 1) occupying a narrow range of alpine habitats (2400 – 3400m) on generally north facing slopes in the Sierra Nevada Mountains near Lake Tahoe. The habitat itself is characterized as alpine (typically above 2750 m.) with areas of this landscape consisting of rocky slopes. These slopes can consist of granitic rock crevices, talus, scree, rocky granitic soils on steep inclines. This area is located mostly in the subalpine conifer zone (dominant conifer is white bark pine) with little understory.

Although large amounts of snow typically fall in the winter, these open alpine peaks tend to be fairly warm and dry in the summer with a soil type that is not conducive to much water retention (a figure summarizing monthly average temperatures and precipitation is given in the Fig. 4 of Ch1).

Selection of Sampling and Long-Term Monitoring Sites

Study sites were established in the all three geographically isolated population clusters of *D. asterophora* to measure abiotic and biotic habitat characteristics. Long-term monitoring sites were established in both the northern and southern clusters (*D. asterophora* var. *asterophora*) to monitor individual plant changes. Extensive abiotic and biotic sampling occurred at these sites. Additionally, some soil samples were collected from additional sites within all three population clusters and both varieties of the taxon.

NORTHERN CLUSTER: *D. ASTEROPHORA* VAR. *ASTEROPHORA*.—This variety *asterophora* in the north population cluster occurs both on and off ski resort property in Washoe County, NV. The

populations at Mt. Rose Ski Resort on Slide Mountain are on private property and Humbolt-Toiyabe National Forest land, including currently utilized ski runs. The populations outside of the ski resort extend up to the top of Church Peak (3235m) on Mt. Rose Mountain in the Humbolt-Toiyabe National Forest. These Mt. Rose populations are divided from the Mt. Rose Ski Resort populations on Slide Mt. by Highway 431.

Long-term monitoring areas in the northern cluster (discussed in Ch. 1) included two populations on ski runs at Mt. Rose Ski Resort (Bonanza ski run, BON; and Bruce ski run) and a more remote site outside the ski resort (Mount Rose Trail, MRT). Additional sites at Mt. Rose Ski Resort (identified by the runs' names) and on Mt. Rose proper (including some sites with a soil substrate appearing to include volcanic rock) were also included as part of the soil sampling.

SOUTHERN CLUSTER: *D. ASTEROPHORA* VAR. *ASTEROPHORA*.—This southern cluster of the variety *asterophora*, occurs exclusively on U.S. Forest Service property (Lake Tahoe Management Basin Unit) in El Dorado County, California, and Douglas County, Nevada. Some populations are within the Heavenly Ski Resort boundaries (including ski runs, road side cuts, and out-of bounds areas). Other populations are on more remote sites outside of the resort at and around Freel Peak (3316m).

Long-term monitoring areas in the southern cluster included two populations at Heavenly Ski Resort (Heavenly Monument Peak, HMP; and Heavenly East Peak, HEP), and a more remote site outside Heavenly Ski Resort at Freel Peak. We also included for soil analyses additional sites at Heavenly Ski Resort (identified by the ski run names) and surrounding Freel Peak (including a small population near Star Lake).

SOUTHWEST CLUSTER: *D. ASTEROPHORA* VAR. *MACROCARPA*.—The southwest cluster, variety *macrocarpa*, occurs exclusively in the Desolation Wilderness, El Dorado County, CA, which has

restricted human use. Specifically, populations occur south of Echo Lake around Cup Lake, Saucer Lake, and on Ralston Peak (2804m). None of these populations exist on ski resort property. We primarily used the populations surrounding Saucer Lake for soil and vegetative analyses, but also included a few soil samples from Cup Lake and Ralston Peak in the soil analyses. We did not establish any long-term monitoring sites in this SW region.

Field Sampling

We began field sampling during the summer season of 2005 and continued sampling yearly through 2008. At long-term monitoring plots, we placed transects through the population with the number and length of each transect depending on the size and shape of the population. We took community measurements and soil samples at points every 2.5 meters along transects lines.

Abiotic & Soil Characterization Methods

We collected composite soil samples from each point along transects established at each long-term monitoring study sites. Additional soil samples were taken from several other locations in all three, population clusters. We used a one-foot soil corer to collect composite samples from each site. Due to the rocky underlying substrate, sometimes the corer was only able to collect soil from the top few inches. We combined soil samples for every five points (taken 1 meter above transect line) along transects for a total of five composite samples per site.

Brigham Young University's Soil Analysis Laboratory (Department of Plant and Wildlife Sciences) analyzed the soil samples for soil texture, percentage of sand, percentage of organic matter, pH, electrical conductivity, and concentrations of biogenic elements (P, K, Ca, Na, Cu, Fe, Mn, and Zn), utilizing methods recommended by Black et al. (1965). Soil texture was determined with a hydrometer. Organic matter was quantified by digestion with 1.0 N potassium

dichromate. Reaction (pH) of the soil was taken with a glass electrode on a saturated soil-water paste. Phosphorous was determined with the iron-TCA-molybdate method on a soil extract taken with 0.2 N acetic acid. Exchangeable bases were freed from the soil with 1.0 N ammonium chloride. Ion concentrations in extract solutions were estimated by atomic absorption.

We analyzed soil data from the various sites using a one-way analysis of variance (ANOVA) to test for significant differences among sites and regions using JMP Pro 9 (SAS Institute Inc. 2010). We determined significant differences in soil characteristics among sites and population clusters of *D. asterophora* using an ANOVA with Tukey post-hoc tests in JMP Pro 9 (SAS Institute Inc. 2010).

Pairwise soil similarity values (using Ruzicka's index of similarity; Ruzicka, 1958) among the individual sites and among the three regional population clusters were used to perform an Unweighted Pair Group Method with Arithmetic Mean (UPGMA) cluster analysis following Ward's method (Ward, 1963).

Along with the soil samples previously discussed, we also recorded aspect, slope and elevation for each sample site to further characterize the abiotic features of *D. asterophora* habitat.

Vegetative Community Characterization Methods

At each of these long-term monitoring sites, we also characterized the plant communities. We sampled the vegetative communities by collecting frequency and cover data of both vegetative and abiotic material using Nested Frequency Quadrat Frames (20 in. per side), also known as pitchfork frames (Smith et al. 1987; Fig. 2). The points and pegs along the frame mark different size quadrats of increasing area on the Nested Frequency Frame and the 8 points are

used for point cover estimates We read these Nested Frequency Frames every 2.5 meters along transects, recording both point cover and nested frequency data.

We determined the frequency class of each species occurring in the pitchfork frame (Smith et al. 1987; Fig. 2). We estimated point cover for abiotic material, litter, total biotic cover and relative cover and frequency of individual plant species in the community, including *D. asterophora*. We used these variables in regression analyses and models. We also compared the similarities of vegetative communities from the long-term monitoring sites (plus one site in the southwest variety *macrocarpa*) using an UPGMA cluster analysis (Ward 1963) based on a Ruzicka similarity index (Ruzicka, 1958) of the relative frequencies of prominent species.

We recorded only species captured using this pitchfork frame in estimates of species richness and in the list in the results tables (Table 2 and Table 3), but this does not imply that other species are non-existent at a particular site. The pitchfork method is a sampling procedure rather than a census, with the caveat that not all species may be detected in the sampling methods. This is especially true for the method estimating cover via points on the pitchfork, since all sites had low percentage biotic cover. In some cases this point-cover method even failed to detect *Draba asterophora*, which was present at each site.

We estimated relative cover and frequency to be used in our analyses. We also calculated species richness (total species encountered through sampling method) and Shannon-Wiener diversity indices (Shannon 1948) for each site using relative frequency values of each species.

We ran multiple regressions to determine the most important abiotic and biotic variables for *D. asterophora* frequency and cover (relative to other species and total) and percent biotic cover as dependent variables to determine the best predictive models. To determine the importance of *D. asterophora* to the vegetative community as a whole, we ran a set of regressions (JMP 9)

including the diversity and richness values and the total vegetative cover values for each site with *D. asterophora* frequency and cover. We also included both frequency and cover of *D. asterophora* as well as total biotic cover as dependent variables to determine which habitat components may be most important (according to BIC best-fit models). We employed a minimum Bayesian information criterion (BIC) to determine the best model and avoid over-fitting the model (Schwarz 1978).

We ran regressions between soil variables and *D. asterophora* frequency, cover, and density (previously estimated in Ch 1) as well as total biotic frequency and cover to determine which abiotic soil components may be most important for biotic growth of *D. asterophora*.

We also conducted regressions between aspect, slope and elevation values and the biotic diversity and species richness values for each site. Finally, we ran regressions between aspect, slope and elevation values and soil trait values for each site to elucidate any relationships between the more general community characteristics and specific soil traits. These relationships may have some bearing on the specific microhabitat requirements of *D. asterophora*. We ran all regressions on the statistical software program JMP Pro 9 (SAS Institute Inc., Cary, NC, 2010).

RESULTS

Abiotic & Soil Characterization Results

Overall, we found many similarities between the abiotic characteristics of the regions (Table 1). All of the sites occur at high elevations, above 2500 m, on west to north facing aspects (ranging from 109°E to 295°W with relatively steep slopes (ranging from 15-34%). Populations occurred on steeper slopes, but were too difficult to access and not used in this study.

The soil composition among sites also displayed some similarities. All of the sites consisted of granitic spere, with relatively low levels of organic matter (all less than 5%, $\bar{x} = 2\%$) and primarily sandy soils (all greater than 70%, $\bar{x} = 83\%$). All of the sites had acidic soils as well (pH ranging from 3.7-4.6). In addition, we found no significant differences between sites for electrical conductivity (EC) of the soil. All EC values were fairly low (<0.5 dS/M).

The sites also displayed similarities in soil chemistry. All of the sites had moderate to high levels of phosphorous (>15 ppm), but moderate to low levels of nitrates (<6.5 ppm) and low levels of potassium (<35 ppm). In addition, all of the sites, except the volcanic site on Mt. Rose proper, had high levels of iron (>50 ppm), although the sites varied significantly from each other ($P \leq 0.05$; Table 1). All sites except Star Lake (Table 1) had low levels of copper ($< 0.6\%$), while Star Lake had significantly higher ($41.18P < 0.05$) levels of copper. Manganese and zinc varied significantly between the sites ($P \leq 0.05$; Table 1).

The three regions did show some significant differences for soil characteristics. Significant differences were also found between the sites within the ski resorts and the more remote sites outside the ski resorts ($P \leq 0.05$; Table 1). The southwest region (variety *macrocarpa*) had significantly higher levels of phosphorous (38 ppm) than the northern region (<25 ppm), as well as the more remote site in the southern region, Freel Peak (22.55 ppm). The southwest region also had higher levels of potassium and higher percentage of organic material than either of the ski resorts as well as Freel Peak ($P \leq 0.05$; Table 1). This southwest region also had significantly higher levels of iron (>160 ppm) than all other sites (<70 ppm) except the Star Lake site (>130 ppm), which is also a more remote area outside of a ski resort next to a lake in the southern variety *asterophora* region instead of the southwest variety *macrocarpa* region. In addition, this southwest region also had a significantly lower average pH level (3.78) than any of remote (non

ski resort) sites in the north (>4.29) and one in the south (Freel; 4.49). There were also significant differences among specific sites ($P \leq 0.05$; Table 1).

In the regional UPGMA cluster analysis based on soil similarity (Fig. 3), the two ski resorts were found to be most similar in regards to abiotic soil composition (0.92). Sites in both the northern and southern regions generally clustered together (0.63 similarity value) separate from a distinct cluster (0.47) consisting only of the southwest region, variety *macrocarpa*, and one remote site in the southern region also by a lake, Star Lake (variety *asterophora*; 0.78). Thus, the abiotic soil chemistry of the *macrocarpa* (Saucer Lake) variety in the southwest region and the Star Lake site (southern region) were found to be more similar to each other and dissimilar to the other sites.

Phosphorus, potassium, and pH were the abiotic traits most associated with *D. asterophora* variables of cover, frequency and density. Acidity (pH) was strongly positively correlated with *D. asterophora* density ($r=0.928$, $P=0.0075$) and cover (total cover: $r=0.889$, $P=0.017$; relative cover: $r=0.901$, $P=0.014$). *Draba asterophora* frequency was negatively correlated with potassium (frequency: $r=-0.810$, $P=0.05$), even though all of the sites had low levels of potassium ($\sim 7-33$ ppm; Table 1). *Draba asterophora* frequency was also negatively correlated with phosphorus ($r=-0.889$, $P=0.0178$). Elevation was also positively correlated with *D. asterophora* density ($r=0.85$, $P=0.0316$), with the caveat that all sites occurred within a fairly narrow range of elevations.

Total vegetative cover was significantly positively correlated with percent silt in the soil ($r=0.794$, $P=0.033$) and negatively correlated with percent sand ($r=-0.96$, $P=0.0006$), although all sites had relatively high percentages of sand ($>70\%$).

Vegetative Community Characterization Results

All of the sites had low biotic cover (<10%) and few total species (Table 2), although our detection method did not necessarily detect all species present at a particular site. Of the sites that detected *D. asterophora*, total living cover of *D. asterophora* ranged from 12.5%-30% and frequency ranged from 20-40% relative to all vegetation.

There were several species that were detected commonly at multiple sites, but none of the species co-occurred with *D. asterophora* at all sites. Only one species was found to co-exist at greater than 70% of occupied sites; *Eriogonum lobbii* was found in five of the seven sites (71.4% coexistence; Table 2). Based on the prevalent species concept (Curtis and Greene 1949), the seven most frequently encountered species included: *Eriogonum lobbii*, *Lomatium nevadens*, *Silene douglasii*, *Bochera howelii*, *Pinus albicaulis*, *Cistanthe umbellata* var. *umbellate* (formerly *Calyptridium umbellatum*), and *Achnatherum-occidentale*. Although the species detected in this sampling are not always representative of all the species at each site, the remote site in the northern region (Mt. Rose Trial) had the most species (11) and the site in the southwest region had the fewest (two).

The variety *macrocarpa* site in the southwest cluster (Saucer Lake) was most vegetatively dissimilar to the var. *asterophora* sites (0.02; Fig. 6). Two of the sites in the southeast region (Freel and HMP) had the most similar vegetative communities (0.43; Fig. 4). All other sites fell between these without any distinct clusters (Fig. 4).

CORRELATIONS BETWEEN *D. ASTEROPHORA* AND COMMUNITY STRUCTURE.—Simple and multiple regressions showed some significant correlations between *D. asterophora* cover, frequency (total & relative), and density and various vegetative variables (species diversity, richness, evenness). *Draba asterophora* frequency, relative cover (percent of total vegetative

cover), and density were all positively correlated with average species richness (frequency: $r=0.882$, $P=0.02$; relative cover: $r=0.967$, $P=0.0071$; density: $r=0.919$, $P=0.0273$).

Draba asterophora cover was significantly positively correlated with Shannon-Wiener species diversity (Shannon 1948; $r=0.821$, $P=0.0125$) and total biotic cover ($r=0.821$, $P=0.0125$). However, relative *D. asterophora* frequency was negatively correlated with total vegetative cover ($r=-0.658$, $P=0.038$). Lastly, *D. asterophora* fecundity measures of brood size and projected seeds per ovule ratios (computed in Ch 1) were also strongly and positively correlated with species diversity (projected seeds per ovule: $r=0.905$, $P=0.034$; brood size: $r=0.917$, $P=0.0283$).

Total vegetative cover was significantly positively correlated with percent silt in the soil ($r=0.794$, $P=0.033$) and negatively correlated with percent sand ($r=-0.96$, $P=0.0006$), although all sites had relatively high percentages of sand (>70%).

PREDICTIVE MODELS.—The best model for predicting total percent cover of *D. asterophora* ($R^2=0.999$, $R^2_{adj}=0.9997$, $P=0.0002$) included positive relationships with abiotic variables of phosphorous ($P=0.0596$) and pH ($P=0.0001$) and Shannon-Wiener's species diversity index (Shannon 1948; $P=0.0003$).

$\% \text{ Total cover } D. \text{ asterophora} = -13.02 + 0.00319 \text{ ppmP} + 2.887 \text{ pH} + 1.384 \text{ species diversity}$

The model that best estimated total *D. asterophora* frequency ($R^2=0.987$, $R^2_{adj}=0.969$, $P=0.018$) included a negative relationship with phosphorous ($p=0.0315$) and positive relationships with pH ($P=0.0671$) and zinc ($P=0.0312$).

$\text{Total Frequency } D. \text{ asterophora} = -4.128 - 0.088 \text{ ppm P} + 2.39 \text{ pH} + 1.335 \text{ ppm Zn}$

The best model predicting total vegetative cover at a site ($R^2 = 0.999$, $R^2_{adj} = 0.999$, $P < 0.0001$) included positive relationships with potassium ($P < 0.0001$), zinc ($P < 0.0001$), and relative cover of *D. asterophora* ($P = 0.0007$).

All years % Biotic cover = $-0.806 + 0.335 \text{ ppm K-av} + 1.675 \text{ ppm zinc} + 0.0164 \text{ relative cover of } D. asterophora$

DISCUSSION

Abiotic Variables

Overall, there were many similarities among the *Draba asterophora* population sites across the three geographic population clusters around Lake Tahoe with respect to abiotic landscape features (aspect, slope, and elevation), soil composition, and vegetative community. The ski resort sites were found to be most similar in terms of soil composition, whereas the variety *macrocarpa* in the southwest cluster, along with another lake site in the southern region were most distinct (Fig. 3).

In general, the results suggest that *D. asterophora*, and especially *D. asterophora* var. *asterophora*, grows in similar habitats. This is likely due to all of the sites having fairly similar underlying substrate, geological history, topology, and weathering agents (e.g. wind, erosion, freeze/thaw; Egli et al. 2004). All are fairly open sites with a granitic substrate, broadly north-facing aspects, and steep slopes in high alpine areas characterized by snow cover in the winter and a short growing season. The similarity in snow-melt date among sites may contribute to similarities in many soil attributes (Stanton, Rejmánek, and Galen, 1994, Litaor et al., 2004). Thus climate variables that affect snowmelt date have impact the abiotic habitat of *D. asterophora*. In addition, tree islands have also been found to influence soil composition and

chemistry on both the windward and leeward sides (Holtmeier and Broll 1992). Thus, altering trees around *D. asterophora* habitat may also change its soil chemistry.

The soil chemistry factors that were found to be most associated with *D. asterophora* were phosphorus, potassium, and pH. Phosphorus and pH were also significant variables in models predicting *D. asterophora* cover and frequency. Acidity (pH) was also strongly positively correlated with *D. asterophora* density, suggesting its importance to *D. asterophora*'s local abundance in the community. All of these are common important factors in alpine communities (Scott and Billings 1964; Bliss 1971; Holtmeier and Broll 1992; Beck and Elsenbeer 1999; Seastedt and Vaccaro 2001; Arnesen, Beck, Engelskjøn 2007).

Both cover and frequency of *D. asterophora* were negatively correlated with potassium, even though all of the sites had low levels of potassium (~7-33ppm; Table 1). Potassium levels were low compared to other alpine sites (~120-210ppm K, Holtmeier and Broll, 1992) and additions of potassium often increased plant growth in other systems (Chapin, Van Cleve, and Tieszen, 1975; Seastedt and Vaccaro, 2001). This suggests that *D. asterophora* is able to tolerate and may even prefer sites with lower levels of potassium.

Soils at *D. asterophora* sites are fairly acidic (pH: 3.78-4.54). This is similar to some other alpine environments (pH: 3.78-5.35; Beck and Elsenbeer, 1999; 3.5-5.2, Litaor et al. 2005; 4.65-5.33, Seastedt and Vaccaro, 2001; 4.5-5.3, Cassagne et al., 2000; 3.5-5.0, Holtmeier and Broll, 1992), but more acidic than others (e.g. average pH: 6.1-6.3; Shiels and Sanford, 2001). Although all sites were acidic (<5), *D. asterophora* appeared to be more robust (greater total and relative biotic cover) in areas with relatively higher levels of pH or lower acidity. Other soil chemicals can also affect the pH, such as nitrogen (Seastedt and Vaccaro 2001). This may have

implication for factors such as nitrogen deposition in the form of rain or snow, as these may increase nitrogen content of the soils and reduce pH, which could affect a site's suitability for *D. asterophora*.

Draba asterophora occurred more frequently in sites with relatively lower levels of phosphorus, although all the sites likely had levels of phosphorus high enough to sustain the extremely small incremental growth of alpine plants (Haselwandter, Hofmann, Holzmann, and Read 1983). However, in the best-fitting model for *D. asterophora* cover, phosphorus was a positive variable, suggesting a somewhat complex relationship. In comparison to other alpine habitats, these *D. asterophora* sites appear to have a similar amount of phosphorus (ppm P: 15.04-38.00) as at least some other alpine soil studies (mature soil: 19.7ppm P, skeletal soil: 21.1 ppm P; Scott and Billings, 1964), particularly those measuring resin inorganic phosphorus at similar soil depths (resin P_i: (µg/g Resin-P:15.35-23.71, Shiels and Sanford 2001; 12-39, Cassagne et al. 2000). Some studies found much higher phosphorus levels in alpine communities than we found (mg/kg P_{ox}: 460-1300, Litaor et al. 2005), where other studies of alpine systems showed phosphorus levels much lower than we found (~2-3ppm, Holtmeier and Broll 1992).

Typically higher levels of phosphorus, along with other nutrients such as potassium and nitrogen, are associated with greater growth (Pereira & Bliss, 1987) even in alpine habitats (Chapin, Van Cleve, and Tieszen 1975; Seastedt and Vaccaro 2001). Because phosphorous is often a limiting nutrient (Körner, Farquhar, and Roksandic 1989; Litaor et al. 2005), it is used in many fertilizers. This may be problematic for *D. asterophora* if additions of phosphorous rich fertilizers are used in close proximity and affect the soil chemistry at populations of *D. asterophora*.

Vegetative Community Discussion

Alpine vegetative communities are highly influenced by a balance between positive and negative interactions between plants (Olofsson 2004; Choler, Michalet and Callaway 2001), as neighboring vegetation can have both beneficial and detrimental impacts on individual plants (Costin 1954; Carlsson and Callaghan 1991; Olofsson 2004). We did not find any specific positive or negative associations between any of the species sampled, but both species richness and Shannon-Weiner diversity index (Shannon 1948) were associated with *D. asterophora* abundance. Specifically, *D. asterophora* frequency, relative cover, and density were all positively correlated with average community species richness. *Draba asterophora* cover was positively correlated with Shannon-Wiener's species diversity (Shannon 1948) and total biotic cover. These findings indicate that the vegetative community is an important to *D. asterophora* abundance, even though there do not appear to be any specific mutualistic, commensal or competitive species relationships. Diversity is also associated with stability (Elton 1958; Tilman & Downing 1994; Tilman, Wedin, and Knops 1996), which may also be beneficial to *D. asterophora*.

In addition, *D. asterophora* appears to play an important role in the community, as relative cover of *D. asterophora* was a significant predictor of percent of total biotic cover in these communities. However, the frequency of *D. asterophora* was negatively correlated with total vegetative cover. This may suggest that *D. asterophora* occurs at greater frequencies where other species are less abundant or take up less space, but still maintain diversity. In addition, the result that *D. asterophora* density (Chapter 1) is correlated with relative frequency and cover, rather than total frequency or cover, may suggest that *D. asterophora* var. *asterophora* tends to be

denser in areas where it is more dominant and where there are fewer other species or where other species are less prominent on the landscape.

While at lower altitudes in arctic and alpine environments plant communities appear to be dominated by negative interactions (Callaway et al. 2004, Olofsson et al. 2002), at higher altitudes, positive interactions seem to be more important (Carlsson and Callaghan 1991; Olofsson 2004, Choler et al. 2001, Callaway et al. 2002) and even drive diversity (Cavieres et al. 2013). However, positive associations sometimes simply reflect different species preferring the same microclimate (Moen 1993; Olofsson, Moen, and Oksanen 1999; Olofsson 2004) and plant interactions may not be that important in determining community structure (Mitchell, Cahill, and Hik 2009). Diversity may also be due to a combination of facilitative plant interactions and climate simultaneously (Cavieres et al. 2013). Interspecific interactions may also depend on the specific plant type and substrate or habitat type where it is located (Egerton and Wilson 1993). In addition, climate may interact with both total community biomass and the types of plant interactions in alpine environments (Kikvidze et al. 2005). Species richness may also be more determined by environmental stress than other factors such as disturbance or competition (Kammer and Möhl 2002). The structure of the community may This may help explain *D. asterophora*'s lack of specific interspecific associations, but also suggests that individual sites may somewhat differ in specific site characteristics.

In addition to the positive correlations of both *D. asterophora* cover and frequency with species richness, species diversity was a significant variable in a model predicting relative cover of *D. asterophora*. These results emphasize the importance of the presence of other species in *D. asterophora* habitat and suggests that *D. asterophora* likely has similar habitat requirements to other (sub)alpine species. These results are consistent with research findings that more diverse

ecosystems are also more stable (Elton 1958; Tilman and Downing 1994, Tilman et al. 1996) as well as that steep, rocky, alpine habitats tend to be sparsely habited (Moore 1965).

Draba asterophora also had greater seed production (both seed/ovule ratio and brood size; Chapter 1) in areas with greater species diversity. Thus, while *D. asterophora* may not be dependent on any particular species in a symbiotic relationship, it does appear to have better growth (as measured by cover) and reproduction (S/O ratio) in habitats with other alpine plants, following this pattern of positive interactions (Carlsson and Callaghan 1991; Olofsson 2004, Choler et al. 2001, Callaway et al. 2002) and ecosystem stability (Elton 1958; Tilman and Downing 1994, Tilman et al. 1996). In addition, patch size, diversity and floral abundance in communities may also attract more pollinators, which may contribute to better seed set (Wyatt 1982; Steffan-Dewentar and Tschardtke 1999; Dauber et al. 2010) whereas a fragmented habitat may result in lower pollinator visitation and lower seed set (Jennersten 1988).

Diversity itself also plays a role in overall community structure (Elton 1958; MacArthur and Wilson 1967; Goheen et al. 2005). Common species are more likely to dominate and comprise a larger proportion of the community in areas of low diversity, while rare species tend to increase in relative abundance or prevalence in areas of high diversity (Goheen et al. 2005). As a rare species, *D. asterophora* shows increased abundance in higher areas of diversity; both *D. asterophora* cover and frequency were positively correlated with species richness.

Implications for Managing Rare Alpine Species

Direct and indirect human impacts on *D. asterophora*'s habitat could affect its conduciveness for *D. asterophora* growth and the stability of its community. Direct disruption, such as road or ski run construction (Johnston and Johnston 2004), ski run grading, or snow making (Rixen, Stoeckli, and Ammann 2003), can also affect soil chemistry (Stanton, Rejmánek, and Galen

1994), underlying topography, erosion (Pohl, Alig, Korner, and Rixen 2009), snow-melt date (Billings and Mooney 1968) and/or the vegetative community (Wipf, Rixen, Fischer, Schmid, and Stoecki 2005). This may impede *D. asterophora*'s growth and ability to respond to disturbances.

Another indirect human impact that could threaten *D. asterophora*'s persistence in these harsh alpine ecosystems is both micro and macro climatic changes. As global climate changes, it is predicted that alpine habitats will become warmer and experience less overall and less predictable snowfall. These changes are likely to impact the habitat as a whole, such as by affecting the timing and amount of water availability, as well as the soil composition and chemistry. In addition, encroachment from lower elevation species is anticipated (Guisan and Theurillat 2000, 2001; Theurillat and Guisan 2001; Pauli, Gottfried, Grabherr, 1996), which may also negatively impact *D. asterophora*.

This has implications for management of rare species in disturbed alpine habitats. Reseeding after disturbances, such as road development, ski run grading, or natural disturbances, even with native (sub)alpine species may negatively impact some rare alpine species. Although no specific negative interactions were detected, personal observation of graded ski runs that were seeded with alpine grasses (e.g. *Sporobolus* spp.) showed that *D. asterophora* was confined to the pockets of boulders surrounding the ski lifts and at the edges of ski runs. *Draba asterophora* had not reestablished itself on the graded and reseeded seed run, even more than 10 years later.

Overall, *D. asterophora* appears to be able to inhabit fairly harsh habitats with little vegetation and few other plant species. It appears to prefer north facing aspects, ranging from almost west/northwest to slightly northeast, in high altitudes (above 2500m). Specific soil chemical compositions varied between sites, but *D. asterophora* cover was positively correlated

with pH. Predictive models for both *D. asterophora* cover and frequency also included a positive correlation with pH, suggesting a preference for relatively less acidic soils (although all soils were still acidic). Its relationships with potassium and phosphorus appear somewhat more complicated. *Draba asterophora* may be more impacted by other factors, such as water availability, than specific soil chemicals. Microclimate and microhabitat may influence some of these factors, such as water available or temperature (Scherrer and Korner 2010)

Draba asterophora does not appear to have many specific soil composition requirements or interspecific interactions, but generally occurs on relatively open north-facing alpine habitats on steep granitic slopes with a diverse vegetative community. Diversity may be an indirect factor supporting the diversity-stability hypothesis (Elton 1958) or indicator of more optimal habitat (e.g. water availability; Moen, 1993; Olofsson, Moen, and Oksanen, 1999; Olofsson, 2004). Maintaining a diverse vegetative community may be a key part of a conservation plan for *D. asterophora*.

Therefore, areas occupied by *D. asterophora* need to be conserved and protected from further human impacts. Species richness and diversity must be maintained in the plant communities associated with *D. asterophora*. This case study on *D. asterophora* adds to the limited literature on rare, alpine plant species.

LITERATURE CITED

- AL-SHEHBAZ, I. 2012. *Draba*, in Jepson Flora Project (eds.) Jepson eFlora, http://ucjeps.berkeley.edu/cgi-bin/get_IJM.pl?tid=23307
- Arnesen, G., P.S.A. Beck, and T. Engelskjøn. 2007. Soil acidity, content of carbonates, and available phosphorus are the soil factors best correlated with alpine vegetation: Evidence from Tromas, North Norway. *Arctic, Antarctic, and Alpine Research* 39(2):189-199.
- BECK, M.A. AND H. ELSENBEER. 1999. Biogeochemical cycles of soil phosphorus in southern Alpine spodosols. *Geoderma* 91:249-260.
- BERGSTROM, ELIZABETH, USFS Botanist. July 2005; August 2013.
- BILLINGS, W.D. AND H.A. MOONEY. 1968. The ecology of arctic and alpine plants. *Biological Review* 43: 481-529.
- BLISS, L.C. 1971. Arctic and alpine plant life cycles. *Annual Review of Ecology and Systematics* 2: 405-438.
- CALLAWAY R.M., G.G. THELEN, A. RODRIGUEZ, AND W.E HOLBEN. 2004. Release from inhibitory soil biota in Europe may promote exotic plant invasion in North America. *Nature* 427: 731–33.
- CALLAWAY, R.M., R.W. BROOKER, P. CHOLER, Z. KIKVIDZE, C.J. LORTIE, R. MICHALET, L. PAOLINI, F.I. PUGNAIRE, B. NEWINGHAM, E.T. ASCHEHOUG, C. ARMAS, D. KIKODZE, AND B. J. COOK. 2002. Positive interactions among alpine plants increase with stress. *Nature* 417 (6891): 844-848.
- CARLSSON, B.A., AND T.V. CALLAGHAN. 1991. Positive plant interactions in tundra vegetation and the importance of shelter. *Journal of Ecology* 79 (4): 973–983.
- CASSAGNE, N., M. REMAURY, T. GEUQUELIN, AND A. FABRE. 1999. Forms and profile

distribution of soil phosphorus in alpine Inceptisols and Spodosols (Pyrenees, France).
Geoderma 95:161-172.

CAVIERES, L.A., R.W. BROOKER, B.J. BUTTERFIELD, B.J. COOK, Z. KIKVIDZE et al. 2013.

Facilitative plant interactions and climate simultaneously drive alpine plant diversity.

Ecology Letters (online first)

<http://onlinelibrary.wiley.com.erl.lib.byu.edu/doi/10.1111/ele.12217/abstract>

CHAPIN, F.S. II, VAN CLEVE, K., AND L.L. TIESZEN. 1975. Seasonal nutrient dynamics of tundra vegetation at Barrow, Alaska. *Arctic and Alpine Research* 7 (3): 209-226.

CHOLER, P., MICHALET, R. AND R.M. CALLAWAY. 2001. Facilitation and competition on gradients in alpine plant communities. *Ecology* 82 (12): 3295-3308.

COSTIN, A.B., 1954: A Study of the Ecosystems of the Monaro Region of New South Wales. Sydney: Government Printer. 860 pp.

CURTIS, J.T. AND H.C. GREENE. 1949. A study of relic Wisconsin prairies by the species-presence method. *Ecology* 30:83-92.

DAUBER, J., J.C. BIESMEIJER, D. GABRIEL, W.E. KUNIN, E. LAMBORN, B. MEYER, A. NIELSEN, S.G. POTTS, S.P.M. ROBERTS, V. SOBER, J. SETTELE, T. TEDER, T. TSCHUELIN, D. VIVARELLI, T. PETANIDOU. 2010. Effects of patch size and diversity on flower visitation and seed set of wild plants: a pan-European approach. *Journal of Ecology* 98(1):188-196.

DAVIS, M.B. AND R.G. SHAW. Range shifts and adaptive responses to quaternary climate change. *Science* 292 (5517): 673-679.

EGERTON, J.J.G. AND S.D. WILSON. 1993. Plant competition over winter in alpine shrubland and grassland, Snowy Mountains, Australia. *Arctic and Alpine Research* 25 (2): 124-129.

- EGLI, M., A. MIRABELLA, A. MANCABELLI, AND G. SARTORI. 2004. Weathering of soils in alpine areas as influenced by climate and parent material. *Clays and Clay Minerals* 54(3):287-303.
- ELTON, C. 1958. *The Ecology of Invasions by Animals and Plants*. Methuen: London.
- ENGELHARDT, B. AND S. GROSS. 2011. Long-term monitoring plan: *Draba asterophora* var. *asterophora* and *Draba asterophora* var. *macrocarpa*. USDA Forest Service, Lake Tahoe Basin Management Unit.
- FORDHAM, D.A., H.R. AKCAKAYA, M.B. ARAUJO, J. ELITH, D.A. KEITH, ET AL. 2012. Plant extinction risk under climate change: are forecast range shifts alone a good indicator of species vulnerability to global warming? *Global Climate Biology* 18:1357-1371.
- GOHEEN, J.R., E.P. WHITE, S.K.M. ERNEST, AND J.H. BROWN. 2005. Intra-guild compensation regulates species richness in desert rodents. *Ecology* 86(3):567-573.
- GUISAN, A. AND J.-P. THEURILLAT. 2000. Assessing alpine plant vulnerability to climate change: a modeling perspective. *Integrated Assessment* 1: 307-320.
- GUISAN, A., & THEURILLAT, J. P. 2001. Equilibrium modeling of alpine plant distribution: how far can we go? *Phytocoenologia* 31(1), 147-148.
- HASELWANDTER, K., HOFMANN, A., HOLZMANN, H.-P., AND D.J. READ. 19983. Availability of nitrogen and phosphorus in the nival zone of the Alps. *Oecologia* 57: 266-269.
- HICKMAN, J.C. (ED.). 1993. *The Jepson Manual*. University of California Press, Berkeley, CA.
- HOLTMEIER, F-K. AND G. BROLL. 1992. The influence of tree islands and microtopography on pedoecological conditions in the forest-alpine tundra ecotone on Niwot Ridge, Colorado Front Range, U.S.A. *Arctic and Alpine Research* 24(3):216-228.
- JBR ENVIRONMENTAL CONSULTANTS, INC. 2004. Mt. Rose Ski Tahoe 2004 Sensitive Species Management Report. Prepared for Mt. Rose Ski Tahoe, Contact Paul Senft. On File Carson

Ranger District, Humboldt-Toiyabe N.F. 5pgs.

JENNERSTEN, O.1988. Pollination in *Dianthus deltoids* (Caryophyllaceae): effects of habitat fragmentation on visitation and seed set. *Conservation Biology* 2(4):359-366.

JMP PRO 9. 2010. SAS Institute Inc.: Cary, NC, 1989-2007.

JOHNSTON, F.M. AND S.W. JOHNSTON. 2004. Impacts of road disturbance of soil properties and on exotic plant occurrence in subalpine areas of the Australian Alps. *Arctic, Antarctic, and Alpine Research* 36 (2): 201-207.

KAMMER, P.M. AND A. MÖHL. 2002. Factors controlling species richness in alpine plant communities: an assessment of the importance of stress and disturbance. *Arctic, Antarctic, and Alpine Research* 34 (4): 398-407.

KIKVIDZE, Z., PUGNAIRE, F.I., BROOKER, R.W., CHOLER, P. LORTIE, C.J., MICHALET, R. AND R.M. CALLAWAY. 2005. Linking patterns and processes in alpine plant communities: a global study. *Ecology* 86 (6): 1365-1400.

KÖRNER C., FARQUHAR G.D., AND Z. ROKSANDIC. 1988. A global survey of carbon isotope discrimination in plants from high altitude. *Oecologia* 74: 623–632. .doi:10.1007/BF00380063.

LITAOR, M.I., T.R. SEASTEDT, M.D. WALKER, M. CARBONE, AND A. TOWNSEND. 2005. The biogeochemistry of phosphorus across an alpine topographic/snow gradient. *Geoderma* 124:49-61

MACARTHUR, R.H., AND E.O. WILSON. 1967. *The Theory of Island Biogeography*. Princeton University Press: Princeton, New Jersey, USA.

MITCHELL, M.G.E., CAHILL, J.F., JR., AND D.S. HIK. 2009. Plant interactions are unimportant in a subarctic-alpine plant community. *Ecology* 90 (9): 2360-2367.

- MOEN, J. 1993. Positive versus negative interactions in a high alpine block field: germination of *Oxyria digyna* seeds in a *Ranunculus glacialis* community. *Arctic and Alpine Research* 25: 201–206.
- MOORE, T. C. (1965). Origin and disjunction of the alpine tundra flora on San Francisco Mountain, Arizona. *Ecology* 46:860-864.
- OLOFSSON, J. 2004. Positive and negative plant-plant interactions in two contrasting Arctic-Alpine plant communities. *Arctic, Antarctic, and Alpine Research*. 36 (4): 464-467.
- OLOFSSON, J., MOEN, J., AND L. OKSANEN. 1999. On the balance between positive and negative interactions in harsh environments. *Oikos* 86: 539–543.
- PAULI, H. M. GOTTFRIED, AND G. GRABHERR. 1996. Effects of climate change on mountain ecosystems – upward shifting of alpine plants. *World Resource Review* 8(3):382-390.
- PEREIRA, P.A.A. AND F.A. BLISS. 1987. Nitrogen fixation and plant growth of common bean (*Phaseolus vulgaris* L.) at different levels of phosphorus availability. *Plant and Soil* 104: 79-84.
- POHL, M., ALIG, D., KÖRNER, C. RIXEN, C. 2009. High plant diversity enhances soil stability in disturbed alpine ecosystems. *Plant and Soil* 324 (1-2): 91-102.
- PRICE, M. 1985. Impacts of recreational activities on alpine vegetation in western North America. *Mountain Research and Development* 5: 263-277.
- RIXEN, C., STOECKLI, V., AND W. AMMANN. 2003. Does artificial snow production affect soil and vegetation of ski pistes? A review. *Perspectives in Plant Ecology, Evolution, and Systematics* 5 (4): 219-230.
- Ruzicka, M. 1958. Anwendung methematisch-statistischer methoden in der geobotanik (Synthetische Bearbeitung von Aufnahmen). *Biologia, Bratisl* 13:647-661.

- SCHERRER, D. AND C. KORNER. Topographically controlled thermal-habitat differentiation buffers alpine plant diversity against climate warming. *Journal of Biogeography* 38(2):406-416.
- SCHWARZ, G.E. 1978. Estimating the dimension of a model. *Annals of Statistics* 6 (2): 461–464.
- SCOTT, D. AND W.D. BILLINGS. 1964. Effects of environmental factors on standing crop and productivity of an alpine tundra. *Ecological Monographs* 34 (3): 243-270.
- SEASTEDT, T.R. AND L. VACCARO. 2001. Plant species richness, productivity, and nitrogen and phosphorus limitations across a snowpack gradient in Alpine Tundra, Colorado, U.S.A. *Arctic, Antarctic, and Alpine Research* 33(1):100-106.
- SHANNON, C.E. 1948. A mathematical theory of communication. *The Bell System Technical Journal* 27:379-423 and 623-656.
- SHIELS, A.B. AND R.L. SANFORD, JR. 2001. Soil nutrient differences between two krummholz-form tree species and adjacent alpine tundra. *Geoderma* 102:205-217.
- SMITH, S.D., S.C. BUNTING, AND M. HIRONAKA. 1987. Evaluation of the improvement in sensitivity of nested frequency plots to vegetational change by summation. *Great Basin Naturalist* 47:299-307.
- STANTON, M.L, REJMANEK, M., AND C. GALEN. 1994. Changes in vegetation and soil fertility along a predictable snowmelt gradient in the Mosquito Range, Colorado, U.S.A. *Arctic and Alpine Research* 26 (4): 364-374.
- STEFFAN-DEWENTER, I. AND T. TSCHARNTKE. 1999. Effects of habitat isolation on pollinator communities and see set. *Oecologia* 121:432-440.
- THEURILLAT, J-P. AND A. GUISAN. 2001. Potential impact of climate change on vegetation in the European Alps: a review. *Climate Change* 50: 77-109.

- TILMAN, D. & J.A. DOWNING. 1994, Biodiversity and stability in grasslands. *Nature* 367: 363-365.
- TILMAN, D., WEDIN, D., AND J. KNOPS. 1996. Productivity and sustainability influenced by biodiversity in grassland ecosystems. *Nature* 379:6567: 718.
- Urbanska, K.M. 1997. Restoration ecology research above the timberline: colonization of safety islands on a machine-graded alpine ski run. *Biodiversity and Conservation* 6:1655-1670.
- WALTER, K.S. AND H.J. GILLETT (EDS). 1997 IUCN Red List of Threatened Plants. 1998. Compiled by the World Conservation Monitoring Centre. IUCN – The World Conservation Union, Gland, Switzerland and Cambridge, UK. 822pp.
- WALTHER, G., BEIBNER, S., AND C.A. BURGA. Trends in the upward shift of alpine plants. 2009. *Journal of Vegetation Science* 16(5): 541-548.
- WARD, J.H. 1963. Hierarchical grouping to optimize an objective function. *Journal of the American Statistical Association* 58(301): 236-244.
- WILSON, E.O. 1985. The biological diversity crisis. *BioScience* 35 (11): 700-706.
- WILSON, E.O. 1993. Is humanity suicidal? *Biosystems* 31 (2-3): 235-242.
- WILSON, E.O. 1999. *The Diversity of Life*. WW Norton & Company.
- WIPF, S., RIXEN, C., FISCHER, M., SCHMID, B., STOECKLI, V. 2005. Effects of ski piste preparation on alpine vegetation. *Journal of Applied Ecology* 42 (2): 306-316.
- WYATT, R. 1982. Inflorescence architecture: how flower number, arrangement, and phenology affect pollination and fruit-set. *American Journal of Botany* 69(4):585-594.

TABLES AND FIGURES

TABLE 1. Abiotic characteristics by regions and sites that support *Draba asterophora* in Washoe and Douglas counties, NV and El Dorado country, CA. Each value represents an average of at least five samples from each site. Means followed by the same letter do not differ at the $P<0.05$ level of significance, whereas exclusively different letters indicate significant differences ($P<0.05$).

	<i>D. asterophora</i> var. <i>asterophora</i> (S)			<i>D. asterophora</i> var. <i>asterophora</i> (N)			<i>D. asterophora</i> var. <i>macrocarpa</i> (Sw)
	Freel	Star	Heavenly Ski Resort	Mt. Rose Proper (MRT)	Volcanic on Mt. Rose Proper	Slide Mt.; Mt. Rose Ski Resort	Saucer & Cup Lakes
Elevation (m)	3327	2803	2920.5	2867	3109	2847	2660
Aspect (°)	295 (W)	350 (N)	342 (N)	285 (W)	109 (E)	359 (N)	318.3 NW
Slope (%)	15	32	28	28	31	34	40
Total Abiotic Cover (%)	94.64	--	85.53	73.79	--	90.53	72.5
%Sand	85.44b	79.29ab	84.70b	74.37a	73.72a	84.69b	80.19ab
%Clay***	6.92a	9.25a	7.76a	9.70a	9.88a	7.60a	7.83a
%Silt	7.64a	11.46ab	7.53a	15.93b	16.40b	7.71a	11.98ab
pH	4.49b	3.96abc	4.08ac	4.29bc	4.54bc	3.99ac	3.78a
EC dSM***	0.26a	0.30a	0.14a	0.42a	0.30a	0.17a	0.23a
%OM	0.96b	4.02ab	1.31b	1.85ab	0.72ab	1.45b	3.69a
Essential Elements							
ppm P	22.55b	29.68ab	26.36ab	20.11b	15.04b	24.48b	38.00a
ppm NO ₃ -N**	2.36a*	4.99a	2.81a	3.56a	1.79a	2.64a	6.02a*
ppm K-ave	14.13b	29.60ab	7.05b	22.40ab	28.80ab	11.89b	32.80a
ppm Zn	0.52bc	2.13a	0.33b	0.43bc	0.38bc	1.12ac	0.75bc
ppm Fe	50.18b	166.64ab	65.31bc	52.21bc	14.97c	58.87bc	139.64a
ppm Mn	3.10ac	13.78abc	2.71a	11.00bc	5.75abc	6.41abc	9.55c
ppm Cu	0.55b	41.18a	0.18b	0.55b	0.27b	0.24b	0.43b

TABLE 2. Percent cover of abiotic, litter, and biotic material in *Draba asterophora* habitat along with relative percent *Draba asterophora* cover and frequency

	<i>D. asterophora</i> var. <i>asterophora</i>						<i>D. asterophora</i> var. <i>macrocarpa</i>	Average of all sites
	SE			NE			(SW)	
	Freel	HMP	HEP	MRT	Bonanza	Bruce	Saucer	
Years data collected	2007	2006 2007 2008	2006 2007 2008	2005 2007 2008	2005 2006 2007 2008	2005 2006 2007 2008	2007	
Total Abiotic Cover (%)	94.6	91.4	79.6	73.8	90.8	90.3	72.5	86.7
Total Litter Cover (%)	0	8.2	15.6	17.1	4.5	4.9	22.5	18.5
Total Biotic Cover (%)	5.4	0.32	4.8	9.1	4.7	4.9	5.0	4.9
<i>Draba asterophora</i> cover (%)	1.8	0	0	2.0	0.74	0.46	0	0.83
Relative <i>Draba asterophora</i> cover (%)	33	0	0	21.9	15.8	9.5	0	13.4
Relative <i>Draba asterophora</i> frequency (%)	30	38.9	30.9	20.3	39.7	17.9	0	25.4
Species Diversity	3.3	3.7	2.7	5.5	4.0	5.2	3.0	3.9

Note: Data was summed across years when multiple years of data were available. Species diversity was calculated using Mac Arthur's Diversity Index (D) based on frequency data.

TABLE 3. Percent relative frequency and cover of prevalent species in *Draba asterophora* communities ranked by average relative frequency.

	<i>D. asterophora</i> var. <i>macrocarpa</i> (SW)	<i>D. asterophora</i> var. <i>asterophora</i> (SE)			<i>D. asterophora</i> var. <i>asterophora</i> (NE)			Avg. of all sites
	Saucer	Freel	HMP	HEP	MRT	Bonanza	Bruce	
<i>Draba asterophora</i>	--	30	49.3	30.8	20.3	39.6	21.7	27.4
Relative cover		33			20.3	13.3	12.5	
<i>Eriogonum lobbii</i>	--	50	17.7	--	2.6	5.8	13.1	12.7
Relative cover		33			2.3	1.5	37.5	
<i>Lomatium nevadense</i>	60.0	--	--	--	8.8	--	--	9.8
Relative cover	50.0							
<i>Silene douglasii</i>	--	10	12.9	34.8	--	1.2	--	8.4
Relative cover		33		62				
<i>Bochera howelii</i>	--	--	--	--	25.4	20.6	5.9	7.4
Relative cover					4.67	1.5	1.3	
<i>Pinus albicaulis</i>	--	--	11.2	25.9	--	4.9	--	6.0
Relative cover				31.7		34.3		
<i>Cistanthe umbellata</i> var. <i>umbellate</i> *	--	--	5.1	11.9	4.3	--	18.1	5.6
Relative cover					4.7		12.5	
<i>Achnatherum occidentale</i> *	--	--	--	--	--	--	34.9	5.8
Relative cover							28.8	
<i>Carex</i> spp.	20.0	--	--	--	14.0	--	--	4.9
Relative cover	50.0				19.0			
<i>Sporobolus</i> spp.	--	--	--	--	21.7	--	--	3.1
Relative cover					43.3			
<i>Penstemon newberii</i>	--	10	--	--	--	5.9	--	2.3
Relative cover						13.5		
<i>Eremogone</i> spp.***	--	--	--	--	--	11.6	3.9	2.2
Relative cover						13.3	6.3	
<i>Penstemon davidsonii</i>	--	--	--	--	--	13.5	--	1.9
Relative cover						22.8		
<i>Polygonum shastense</i>	--	--	--	--	9.9	1.0	--	1.6
Relative cover					5.7			
<i>Mimulus angustifolius</i>	--	--	--	--	--	--	2.5	0.4
Relative cover								

TABLE 3. Cont.

	<i>D. asterophora</i> var. <i>macrocarpa</i> (SW)	<i>D. asterophora</i> var. <i>asterophora</i> (SE)			<i>D. asterophora</i> var. <i>asterophora</i> (NE)			Avg. of all sites
	Saucer	Freel	HMP	HEP	MRT	Bonanza	Bruce	
<i>Oenothera xylocarpa</i>	--	--	--	--	2.0	--	--	0.3
Relative cover								
<i>Chaenactis alpigena</i>	--	--	--	--	1.5	--	--	0.2
<i>Phacelia hastata</i> ssp. <i>Compacta</i>	--	--	--	--	0.9	--	--	0.1

All species encountered are native to this region. Recent name changes as indicated by asterisks:

* formerly *Calyptridium umbelatum*

** formerly *Stipa* spp.

***formerly *Arenaria* spp

Notes: Relative cover is displayed when the sampled value is >0. This is not a complete list of species present.

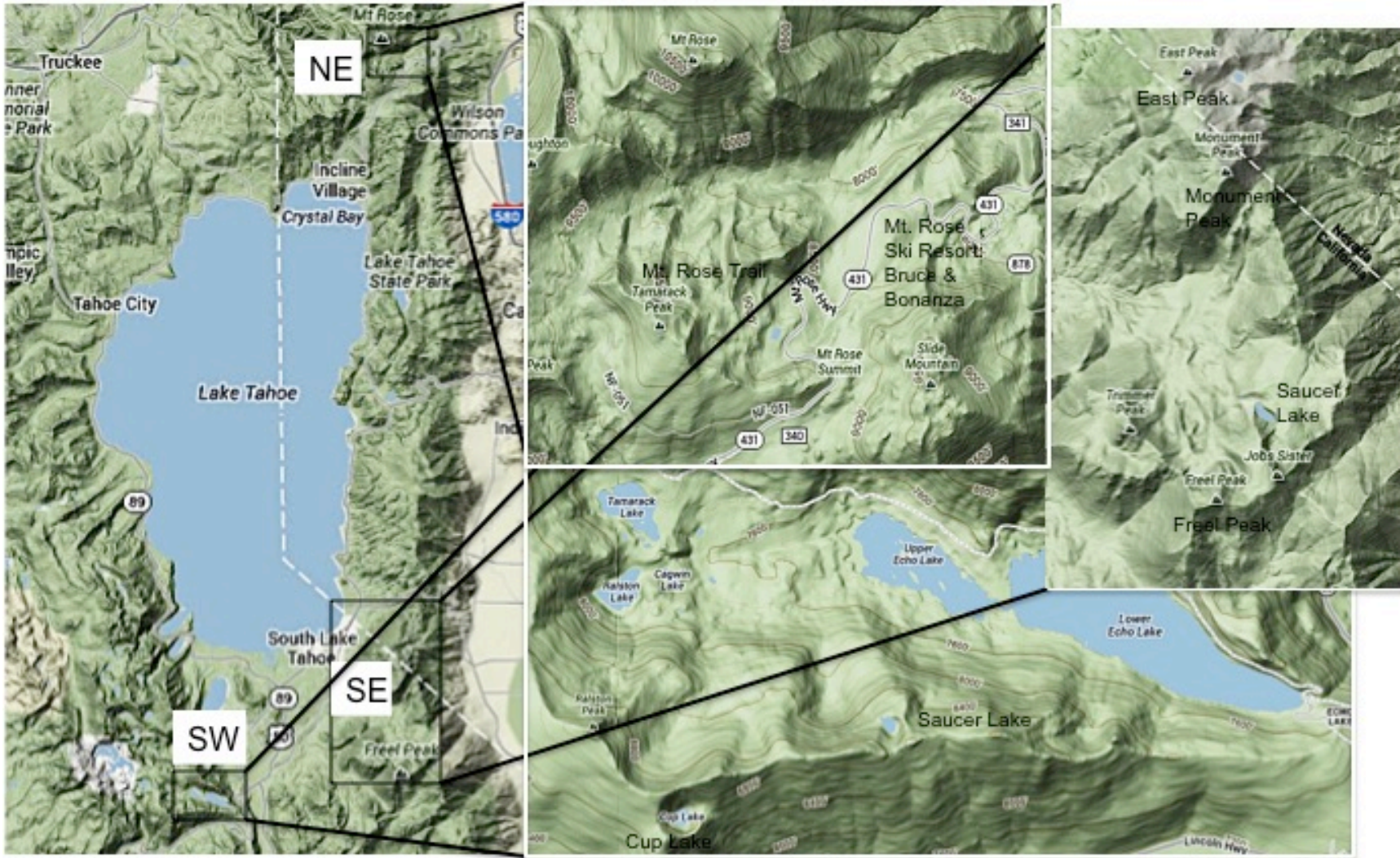

Fig. 1. Map of *Draba asterophora* population clusters. (Photo credit: google maps; maps.google.com)

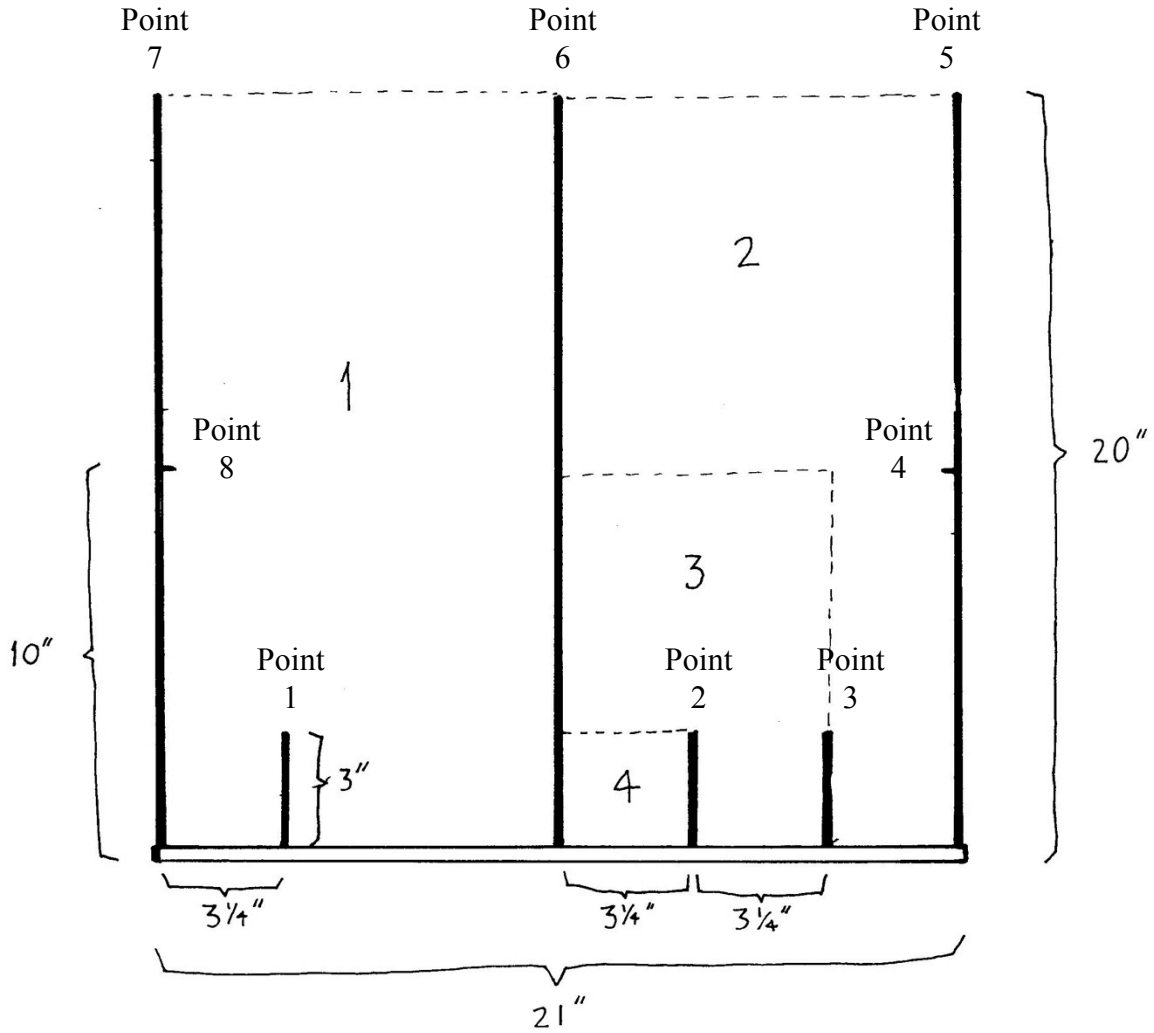

Fig. 2. Nested Frequency Quadrat Frames or pitchfork frames (Smith et al. 1987)

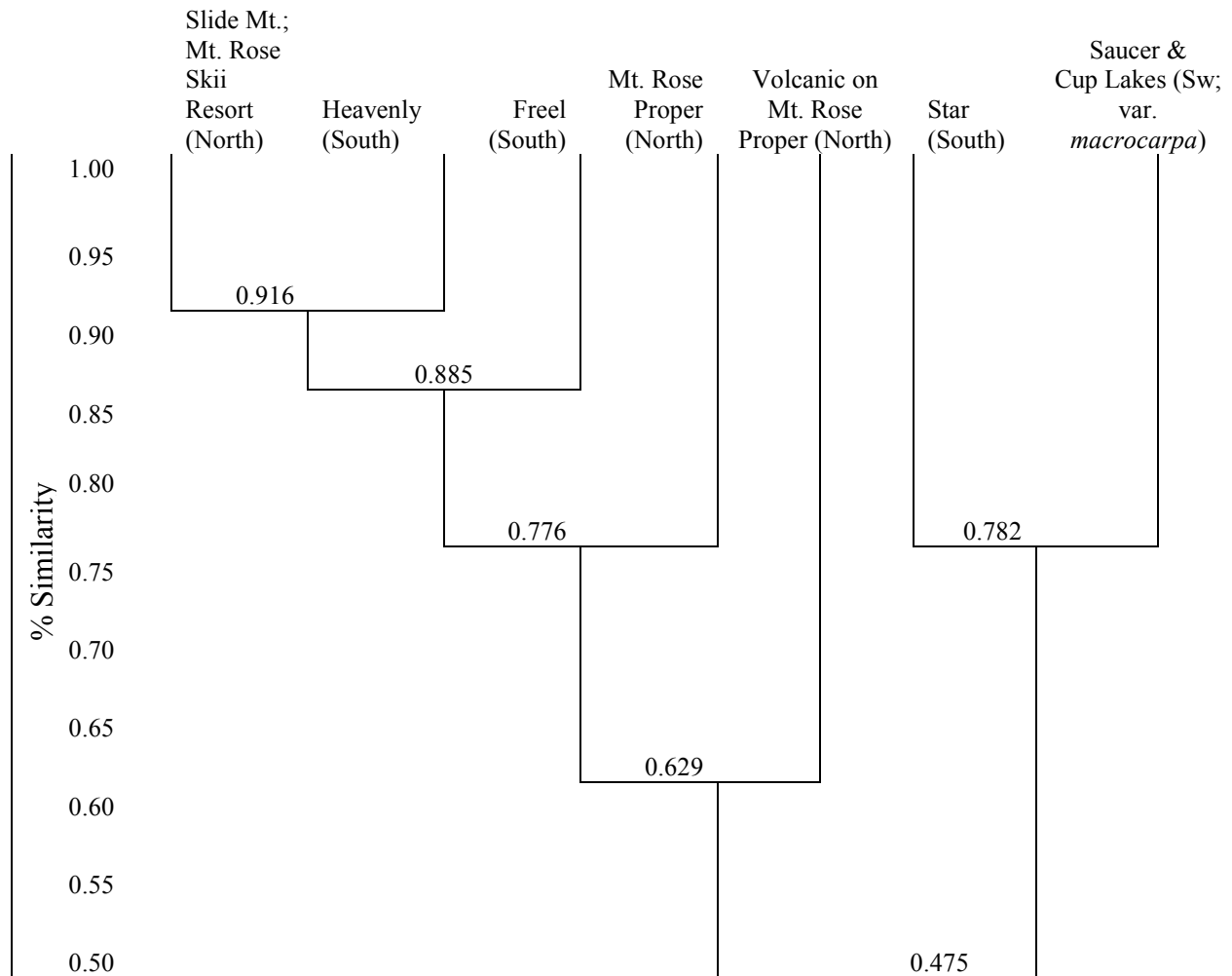

Fig. 3. Unweighted Pair Group Method with Arithmetic Mean (UPGMA; Ward, 1963) by region in terms of soil composition based on a Rusicka similarity matrix (Ruzicka, M. 1958). The region of each site is indicated in parentheses. The southwest variety *macrocarpa* is also indicated in parentheses, all others are variety *asterophora*.

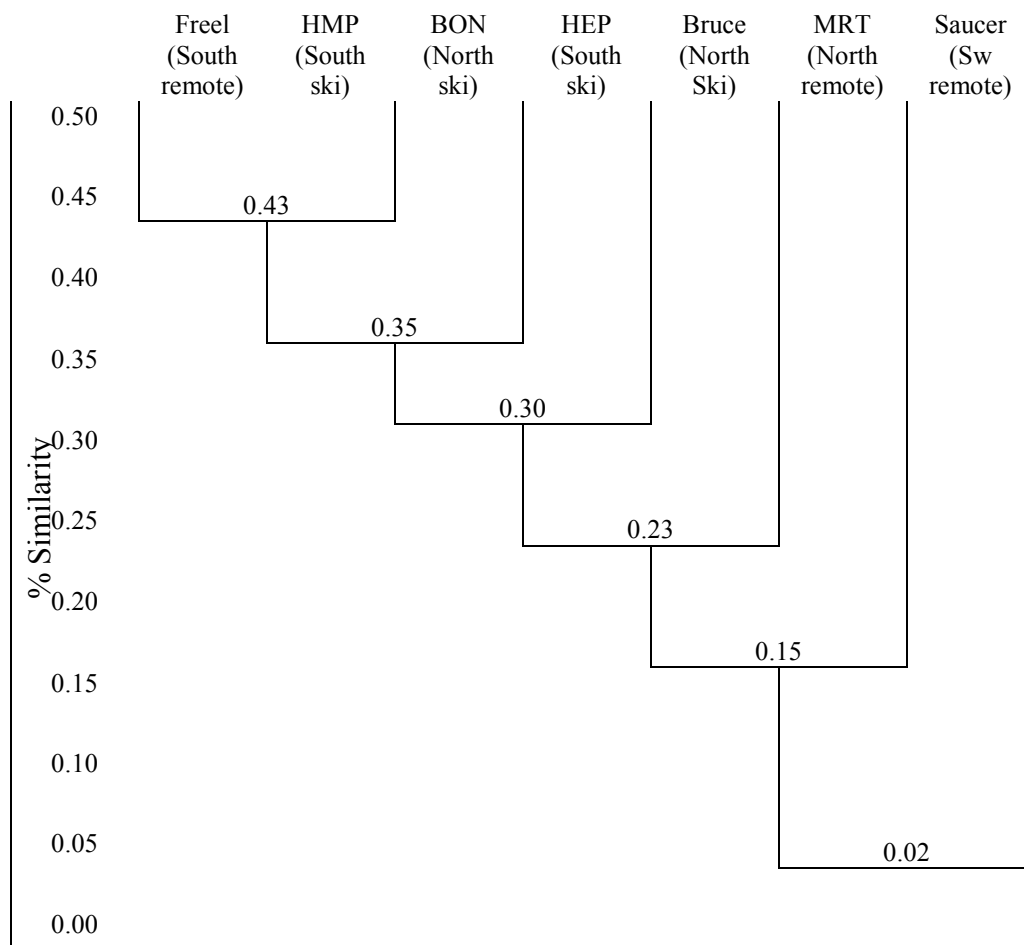

Fig. 4. Unweighted Pair Group Method with Arithmetic Mean (UPGMA; Ward, 1963.) Cluster Analysis of vegetative community by site according to a Rusicka similarity matrix (Ruzicka, M. 1958) based on relative frequencies of prominent species at each site. (Sw=southwest cluster)

CH 3: SPECIES DELINEATION OF THE *DRABA ASTEROPHORA*
COMPLEX UTILIZING PHYLOGENETIC AND CYTOGENETIC DATA

ABSTRACT

Draba is the largest and most diverse genus in Brassicaceae, the mustard family. The genus has complex phylogenetic relationships among species due to high degrees of reticulate evolution, polyploidization, rarity and endemism. *Draba asterophora* is a rare and endemic *Draba* species that occurs in three geographically disjunct regions in the Sierra Nevada Mountains surrounding Lake Tahoe. The three geographic clusters representing the *D. asterophora* complex have not been included in previous phylogenetic analyses. Only the northern population has been examined cytologically ($2n=40$). Thus, its taxonomy of this species complex is poorly understood. We utilized one nuclear molecular marker, ITS, as well as two new chloroplast markers, *trnS-G* and *trnH-psbA*, to help resolve taxonomic relationships and delimit species boundaries within the *D. asterophora* complex. In addition, we examined the cytogenetics of all three population clusters to determine any differences in ploidy levels. The *D. asterophora* complex appears to be composed of three separately evolving trajectories differentiated by separate geographic regions surrounding Lake Tahoe, CA/NV. This is supported by both phylogenetic analyses as well as cytology. The combined DNA concatenated analysis demonstrated that all three regions form separate branches within the *D. asterophora* clade. Cytologically, all three regions had distinct chromosome counts with the southern cluster being a diploid ($2n=20$), the northern cluster being an auto-tetraploid ($2n=40$), and the southwest (variety *macrocarpa*) being an auto-octoploid ($2n=80$). Based on these findings, we recommend that the three population clusters be treated as distinct taxonomic entities for conservation purposes. This research demonstrates the importance of phylogenetics and ploidy levels for taxonomic resolution of rare species across disjunct habitats.

Draba L., the largest genus in Brassicaceae (Al-Shehbaz 1984, 1987; Rollins 1993; Cronquist 1968), is generally monophyletic (Koch and Al-Shehbaz 2002; Bailey et al. 2006; Beilstein, Al-Shehbaz, and Kellogg 2006; Jordan-Tayden, Hase, Al-Shehbaz, Koch 2010), with a worldwide distribution. However, there is poor phylogenetic resolution within the genus itself. The phylogenies are complicated by high degrees of polyploidy (both autopolyploidy and allopolyploidy), and hybridization (Beilstein and Windham 2003, Bailey et al. 2006).

There are two general ploidy types within *Draba*, euploids and aneuploids (Mulligan 1966, 1972, 1974, 1976). Mulligan (1966) first recognized that European species within *Draba* typically have chromosome numbers based on $x=8$. Thus, the first ploidy type in *Draba* is based on this presumed ancestral chromosome base number ($x=8$; Koch and Al-Shehbaz 2002) and is referred to as euploid. Euploid *Draba* consist of diploids with an $x=8$ chromosome number and polyploids with chromosome numbers that are multiples of $x=8$.

However, many North American *Draba* species have base chromosome numbers that are different from euploids ($x \neq 8$). These North American *Draba* species have a much broader range of base chromosome number ($x=9-17, 27, 37$; Mulligan 1976; Brochmann, Borgen and Stedje 1993; Windham 2000, 2003) and are commonly referred to as aneuploids (Windham 2000, 2003). Aneuploid *Draba* are often fully functional diploids with perfectly pairing bivalents (Windham 2000, 2003). Mulligan (1966) hypothesized that evolution in North American *Draba* has taken place through aneuploidy at the polyploid level. He suggested that duplicate genetic material may have been lost from higher ploidy levels, contributing to a reduction in chromosome number (Mulligan 1966).

Phylogenetic studies have demonstrated that there is genetic division between the different ploidy types, with core clades being dominated by either euploids or aneuploids (Beilstein and Windham 2003; Jordan-Tayden et al. 2010).

Rarity and endemism are common to *Draba* (Windham 2000, 2003), especially among aneuploid species in western North America. Windham (2000) explained that many species assigned to *Draba* require mountainous habitats. Suitable habitats in these mountainous regions are disjunct, favoring isolation and speciation. Thus, there are many rare *Draba* species that occur in small isolated populations on mountain peaks (Windham 2000, 2003).

Draba asterophora Payson, or Tahoe Star Draba, is a rare, aneuploid endemic species complex from alpine communities in the Lake Tahoe region of Douglas and Washoe Counties in Nevada and El Dorado County in California, USA. The species complex consists of two currently recognized varieties from three geographically disjunct alpine areas, varieties *asterophora* and *macrocarpa* (Rollins 1993). *Draba asterophora* var. *asterophora* encompasses geographical population clusters in the Sierra Nevada peaks to the north and to the south of Lake Tahoe. *Draba asterophora* var. *macrocarpa* C.L. Hitchcock includes populations to the southwest of Lake Tahoe. These population clusters are isolated on mountain islands making any gene flow between them highly unlikely due to the inhospitable low-elevation matrix of the geographic distance between them (Daubenmire 1943, Moore 1965, MacArthur and Wilson 1967).

However, the taxonomy in the *D. asterophora* complex is poorly understood. Differentiation of the two taxa is based on slight morphological differences, such as a larger fruits and longer styles in the variety *macrocarpa* (Rollins, 1993). The relationship

of *D. asterophora* to other aneuploid *Draba* species is also basically unknown. No previously published phylogenies for *Draba* have included *D. asterophora* (Beilestein and Windham 2003; Bailey et al.; Jordan-Thaden et al. 2010).

Windham (2003) provided the first chromosome counts for this species complex with limited sampling near the type locality at Mt. Rose Ski Resort. He found that the populations of *D. asterophora* var. *asterophora* at the type locality north of Lake Tahoe yielded a chromosome count of $n=20$. From the observance of 10 quadrivalents during diakinesis, Windham concluded that this population represented an autotetraploid (with a $x=10$ base chromosome number; Windham 2003). Thus, Windham (2003) designated the populations of *D. asterophora* var. *asterophora* in the northern population cluster as aneuploid, tetraploid populations. However, no chromosome counts were made for the isolated populations in either the south or southwest clusters of *D. asterophora* surrounding Lake Tahoe.

Conservation plans for *D. asterophora* would be improved by a clearer understanding of the taxonomic relationships within this species complex. Phylogenetics and cytogenetics have been increasingly used in species delineation (Brower 1999; Sites and Marshall 2004; Wiley and Lieberman 2011; Soltis and Soltis 2009). Thus, for this study, we used both cytogenetics and phylogenetics for species delimitation within the *Draba asterophora* complex (Sites and Crandall 1997; Sites and Marshall 2004; Wiens 2007). If the three geographically segregated clusters represented separately evolving metapopulation lineages, each would qualify for recognition as separate species under de Queiroz's (1998, 2005, 2007) unified species concept, or general lineage concept (GLC).

The main objective of this study was to delineate appropriate species boundaries within the *D. asterophora* complex. Specifically, we wanted to:

1) DETERMINE PHYLOGENETICS RELATIONSHIPS AMONG THE THREE *DRABA* *ASTEROPHORA* POPULATION CLUSTERS.—Particularly, we wanted to determine whether the three population clusters: A) represent a single species, *D. asterophora*, with two varieties (variety *asterophora* and variety *macrocarpa*) as currently circumscribed, B) represent a single species without varietal taxa, or C) represent three distinct taxa. We also wanted to investigate which species may be closest relatives to *Draba asterophora* from within the genus, *Draba*. Hitchcock (1941) considered *D. lemonii* to be the most closely related species.

2) DETERMINE PLOIDY LEVELS OF EACH POPULATION CLUSTER OF *DRABA* *ASTEROPHORA*.— Specifically, we wanted to perform a more thorough sampling of chromosome numbers in the *D. asterophora* complex. We wanted to obtain chromosome materials from all populations across all three geographic population clusters to determine the variation in chromosome number and ploidy levels in this species complex. We also wanted to identify whether polyploids may have originated through auto- or allopolyploid events.

METHODS

Taxon Sampling

We collected leaf tissue samples of *D. asterophora* from multiple populations within all three clusters (Fig. 1). Ten individuals were sampled from at least two populations in each of the geographic population clusters. Sampled individuals of *D. asterophora* were

chosen using the point-quarter method (Cottom and Curtis, 1956). Tissue samples, collected in the field, were dried and stored in silica gel prior to DNA extraction procedures.

Additional *Draba* taxa were collected (53 collected taxa; Table 1), primarily from the Intermountain West region of North America, to provide a context for assessing *D. asterophora* relationships and determine any close relatives. We also incorporated some *Draba* sequences (ITS) from *genBank* in analyses. A complete list of which taxa were used in which analyses is available in Table 1.

All dried samples were processed for extraction, amplification and sequencing. DNA was extracted from tissue samples using a 1X CTAB extraction buffer following the procedures of Bult et al. (1989).

DNA Sequencing

MOLECULAR MARKERS.—For this study, we used three molecular markers to generate a phylogeny for *Draba*. We selected rapidly evolving intron and intergenic spacer regions from both the nuclear (internal transcribed spacer region of nuclear ribosomal DNA including ITS1, 5.8S, and ITS2; referred to as ITS) and chloroplast genomes (*trnS-trnG* and *trnH-psbA* intergeneric spacers; referred to as *trnS-trnG* and *trnS-psbA*; Shaw et al. 2005). We chose the nuclear molecular marker (ITS) because it has shown utility in previous phylogenetic *Draba* studies (Koch and Al-Shehbaz 2002; Beilstein and Windham 2003; Koch, Al-Shehbaz, and Mummenhoff 2003; Bailey et al. 2006; Beilstein, Al-Shehbaz, and Kellogg 2006; Jordan-Thaden et al. 2010). We also used two new chloroplast molecular markers (*trnS-trnG* and *trnH-psbA*). We used both nuclear

and chloroplast markers to investigate both maternal and paternal lineages, in order to reveal discrepancies that might be due to hybridization.

The PCR reactions were performed in a total volume of 30 μL containing Qiagen colorless 10x buffer, 1.8 μL MgCl, 4.5 μL glycerine, 0.9 μL of each primer (Table 2), 0.45 μL of combined dNTPs, 0.1 μL Taq DNA polymerase (Qiagen), and 0.3 μL of DNA using a PTC200 (Peltier) thermal cycler. The amplification program included a denaturing step for 2 min at 95°C, followed by 29 cycles of 60 seconds denaturing at 95°C, 60 seconds annealing at 52°C, 60 seconds elongation at 72°C; then a final elongation of 7 min at 72°C.

PCR products were checked for length and concentrations on 1.5% agarose gels, stained with ethidium bromide, but later switched to non-toxic Sypro Ruby Red. Prior to sequencing, the obtained PCR products were purified using a PCR product purification kit (PrepEase milipore PCR purification by USB, Molecular Biology Reagents and Biochemicals). Target products were sequenced at the Brigham Young University Sequencing Center, Provo, UT, USA.

SEQUENCE SELECTION AND COMPILATION OF ALIGNMENT.—Sequences were assembled automatically and subsequently adjusted by hand using SEQUENCHER 4.6 (Gene Codes 2000). Separate matrices for each of the molecular markers were created. A concatenated data matrix was also created using species for which we had obtained sequences from all three molecular markers. Some additional sequences were obtained from *genBank* to expand the scope of the ITS data set. All sequences were then aligned using MUSCLE (Edgar, 2004) and reviewed in Mesquite version 2.75 (Maddison and Maddison 2011).

Phylogenetic analyses

MAXIMUM PARSIMONY (MP) AND MAXIMUM LIKELIHOOD.—We conducted unweighted maximum parsimony analyses in PAUP* v.4.0 beta10 (Swofford 2002) using the heuristic search algorithm with Tree Bisection and Reconnection (TBR) branch swapping and random stepwise addition. Maximum likelihood analyses were also conducted in PAUP* v.4.0 beta10 (Swofford 2002). All characters were considered unordered and equally weighted. Nodal support values for the consensus trees were determined using bootstrap method, with 1000 replicates for the combined dataset (Felsenstein 1985).

BAYESIAN ANALYSES.—MrBayes v.3.4 (Ronquist and Huelsenbeck, 2003) was used to perform searches of Bayesian Inference for each of the individual molecular markers and the combined dataset. We tested various models available in MrBayes v.3.4 with the concatenated dataset and obtained similar results for each with only slightly different posterior probabilities. Therefore, we chose the most basic model (equal rates) in MrBayes v. 3.4. We sampled 10000000 generations on 4 chains using Monte Carlo Markov Chain Metropolis Coupling in MrBayes v.3.4 (Ronquist and Huelsenbeck, 2003).

Cytology

Chromosome counts were made from flower buds collected from wild populations in all three population clusters within the *D. asterophora* species complex. Buds were collected from at least 10 individuals in each population where buds were available. We utilized Windham's (2000) protocol for chromosome fixation and staining. Buds were fixed in a solution of 70% ethanol and 30 % glacial acetic acid and then stored in a

freezer until chromosome squashes could be performed. Buds were macerated in a drop of 1% acetocarmine stain and then mixed with equal parts of Hoyer's solution (chloral hydrate). Slides were examined under an Olympus BH-2 phase contrast microscope and representative slides from each population were photographed using Kodak Technical Pan 2415 film.

RESULTS

In all phylogenetic analyses, *D. asterophora* emerged as a monophyletic clade. This monophyletic clade was part of a larger clade predominately comprised of other yellow aneuploid (base chromosome numbers other than $x=8$) species from the Intermountain West Region of North America (Fig. 2-5; e.g., *D. maguirei* C.L. Hitchc. and *D. burkei* (C. L. Hitchcock) Windham & Beilstein from UT, *D. juniperina* Dorn from WY/n.UT, *D. asprella* Greene from UT & NM, *D. sphaerocarpa* from ID, *D. sphaeroides* Payson from NV, *D. graminea* Greene from CO, and *D. subalpina* Goodman and C.L. Hitchc. from UT). However, the clade included some more wide spread species as well (*D. albertina* Greene, *D. crassifolia* Graham). In the concatenated analysis, *D. asterophora* was part of a larger clade that consisted only of other new world aneuploids, also endemics of the Intermountain West Region.

The closest relatives of *D. asterophora* are still poorly resolved, as the species complex did not have any consistent sister species across all analyses. In the *trnH-psbA* analyses (Fig. 3), *D. asterophora* formed a monophyletic group sister to *D. subalpina*, a white flowered aneuploid. Conversely, in the ITS analysis, the entire *D. asterophora* clade was instead found to be sister to *D. crassa* (Fig. 2). In the analysis of the nuclear

region ITS, *D. subalpina* was found to be part of the same large clade as *D. asterophora*, but not sister to it. Instead, *D. subalpina* formed a polytomy with *D. sobolifera*.

Because Hitchcock (1941) considered *D. lemonii* to be the most closely related species to *D. asterophora*, it was included in the ITS analysis and was not found sister to *D. asterophora*, even though it did emerge as part of the same large clade.. Lastly in the concatenated analysis, the *D. asterophora* complex emerged next to *D. juniperina* (neither *D. subalpina* nor *D. crasa* were included in this analysis). *Draba asterophora* was part of a clade that also included *D. asprella* and *D. mogollonica* (Fig 5), both Intermountain West aneuploids.

Within the *D. asterophora* clade, one of the geographic population clusters emerged on a separate branch while the other two formed a polytomy in each of the three separate molecular phylogenies. Interestingly, in each analysis a different geographic population cluster was segregated out as being unique. In the *trnH-psbA* analysis, the population cluster in the northern region formed a separate unique branch apart from the two southern regions, which were not segregated from each other (Fig. 3). On the other hand, the population cluster in southern region was segregated as its own branch within the *D. asterophora* clade using the *trnS-trnG* analysis (Fig. 4). In contrast, the separate variety *D. asterophora* var. *macrocarpa* formed a separate branch within the clade using the nuclear ITS analysis (Fig. 2). However, when all data were considered together in the concatenated analysis, each of the geographically separated population clusters within *D. asterophora* emerged as distinct branches on the phylogeny (Fig. 5).

Chromosome counts from each population cluster indicated three distinct ploidy levels among the three geographic population clusters (Fig. 6). All chromosome counts

from specimens from the northern population cluster were tetraploid ($2n=40$) and appeared to be an autopolyploid ($2n=40$) with primarily quadrivalents (Fig 6d.). However some rod quadrivalents and bivalents were also observed (Fig d).

The southern cluster yielded primarily diploid chromosome counts ($2n=20$), with the exception of one site (Star Lake) having both diploid and a few triploid chromosome counts (Fig. 6a& b.). However, cells from the triploid chromosome counts did not appear to be from a stable apomictic triploid. Moreover, all of the chromosome counts from long-term monitoring sites in the southern population cluster were diploid (Fig. 6a).

Lastly, the southwest region had the most total chromosomes ($2n \approx 80$), with multiple crossing over locations and long chains of chromosomes, suggestive of an auto-octoploid (Fig. 6c& d.). Chromosome counts was difficult to obtain due to the extensive crossing over of chromosomes, but all populations in the southwest cluster appear to be $2n=80$. The high number of chromosomes indicates it has a different ploidy level from the other two population clusters.

DISCUSSION

The *D. asterophora* complex was consistently supported as a monophyletic clade in all analyses for both chloroplast and nuclear genetic data and in the combined analysis (Figs. 2-5). This monophyletic clade emerged in the same large clade as other mostly yellow-flowered aneuploid *Draba* species, many of which are also endemic to the Intermountain West Region of North America (such as *D. magueri*, *D. burkei*, *D. juniperia*, *D. subalpina*). This supports previous phylogenetic analyses that have found a North American clade that is made up of yellow-flowered species with

aneuploidy ($x \neq 8$) chromosome counts, many of which are confined to high alpine peaks in the Intermountain West (Beilstein and Windham 2003; Jordan-Thaden et al. 2010). Although further research will be needed to resolve *D. asterophora*'s closest relative(s), *D. lemonii*, as proposed by Hitchcocki (1941), is not supported as *D. asterophora*'s closest relative in our analyses.

Phylogenetics and cytogenetics have been increasingly used in species delineation (Brower 1999; Sites and Marshall 2003, 2004; Wiley and Lieberman 2011; Soltis and Soltis 2009), especially in complex groups with morphologically similar, or cryptic species (e.g. Janzen et al. 2005 using DNA Barcoding with Lepidoptera fauna; Zomlefer et al. 2006 on cryptic species in *Schoenocaulon* – Liliales: Melanthiaceae; Johnson and Cairns-Heath 2010; Johnson et al. 2012; and Johnson, Gowen and Jensen 2013 on cryptic *Navarretia*; Johnson 2002 in *Draba*). This can be especially useful in distinguishing between cryptic species that may be hybrids, auto- or allo-polyploids, and convergent evolution. If a hypothesized species is a hybrid or autopolyploid, it can be assumed that it will fall out sister to at least one of its parents or progenitors. Although chromosomes do not always receive the attention they deserve in conservation genetics or systematics, chromosome variability can play an important role in genetic diversity for conservation purposes (Allendorf and Luikart 2007) as well as species delimitation (Otto and Whitton 2000; Soltis et al. 2007; Soltis and Soltis 2009).

Each of the three geographically isolated population clusters of *D. asterophora* was supported as its own monophyletic branch in the combined concatenated analyses (Fig. 5). This provides one line of evidence that these are separate evolving metapopulations under de Queiroz (1998, 2005, 2007) general lineage concept (GLC) of a species. These

monophyletic population clusters would also be supported as separate species under the operational criteria of phylogenetic species methods of species delimitation (Baum and Donoghue 1995; Baum and Shaw 1995; Brower 1999; Sites and Marshall 2004). All three geographic regions were supported as separate monophyletic branches. Thus, if variety *macrocarpa* is to be recognized as a separate entity, there is equal phylogenetic support for recognition of each of the population clusters (representing variety *asterophora*) (in the northern and southern regions) as separate taxonomic entities.

These data support the hypothesis that the three geographic regions are on separate evolutionary trajectories and should be treated as distinct taxa for conservation purposes. In addition, each geographic population cluster was found to have a unique ploidy level, supporting the hypotheses of separately evolving lineages (Soltis and Soltis 2009). Our results also confirm Windham's (2000) assessment of the northern population cluster as a tetraploid ($x=10$, $2n=40$), likely arising from autopolyploidy (the chromosomes generally formed quadrivalents). Chromosome counts from the southern population cluster appeared to be a stable diploid, forming bivalents. The only exception was a population in the southern region, Star Lake, where mixed chromosome counts were found, including primarily diploid and a few triploid chromosome individuals. The triploid chromosome numbers are not likely representative of a stable apomitic triploid, but more likely due to disrupted meiosis in pollen formation. Variety *macrocarpa* (southwest cluster) had an octoploid chromosome count $2n=80$, also likely derived through autopolyploidy.

These genomic, chromosomal differences among the three geographic population clusters provide a further barrier to gene flow, beyond the difficulties due to geographical

isolation (Müntzing 1936; Soltis et al. 2007; Husband and Sabara 2003), and has been recognized as a source of sympatric speciation in plants (Otto and Witton 2000). As early as 1936, Müntzing recognized that “chromosome races are generally separated from each other by barriers of incompatibility and sterility”.

Allopolyploids have traditionally been considered more frequent and more important for speciation in angiosperms than autopolyploids. Only recently have these assumptions been challenged (Soltis and Soltis 1993, 1999; Soltis and Soltis 2000, 2009; Soltis et al. 2007). A few early taxonomists (e.g. Stebbins 1950) recognized the importance of polyploidy as a mechanism of speciation and included autopolyploidy as a source (Müntzing 1936). However, since the modern synthesis, autopolyploidy has largely been ignored as a source of speciation (e.g. Grant 1981), until recently (Soltis, Soltis, and Tate 2003; Soltis et al. 2007).

This revived focus on polyploidy has revealed that autopolyploidy is more common than previously thought (Soltis et al. 2003, 2007; Halverson et al. 2008) and can also be a mechanism of speciation (Soltis et al. 2007; Soltis and Soltis 2009). Soltis et al. (2007) explored three reasons why autopolyploidy was largely ignored as a source of speciation: 1) autopolyploidy was traditionally considered rare, 2) the tradition of naming species was strongly based on morphological traits, and diploids and autopolyploids are often morphologically similar, and 3) there was the belief that “cytotypes” were not reproductively isolated (Soltis et al. 2007).

These arguments are now being challenged. Ramsey and Schemske (1998) estimated high rates of autotetraploids, higher than rates of genetic mutations. Autopolyploidy has also been found to be particularly rampant in certain angiosperm groups (Soltis et al.

2007), such as Saxifragaceae (Soltis and Rieseberg 1986; Soltis et al. 2007), Cactaceae (Cota and Philbrick 1994; Hamrick, Nason, Fleming, Nassar 2002), Poaceae (Keeler and Davis 2004), Brassicaceae (Brochmann et al. 2004). In addition, where autopolyploidy is prevalent, it can shape evolutionary dynamics (Halverson et al. 2008; Otto and Whitton 2000; Soltis et al. 2009; Jiao et al. 2011).

In addition, Soltis et al. (2007) argue that the failure to name autopolyploids as separate species has resulted in a serious underestimate of the role of polyploidy in plant speciation (Schemske 2000; Soltis et al. 2007). More recently such cytological differences between groups have been used as justification for separating species. This is particularly important for Brassicaceae which has extensive hybridization and polyploidization (Beilstein and Windham 2003; Bailey et al., 2006). Using cytological data may be particularly informative in cryptic species (Majure et al. 2012; Johnson et al. 2012). In addition, recognition of these taxa as unique from their progenitors has significant implications for conservation management and maintenance of the unique evolutionary lineages within *D. asterophora*.

Both our phylogenetic and cytogenetic analyses provide evidence that all three of the geographically isolated population clusters are on their own evolutionary trajectories and thus warrant recognition as separate taxa. The hypothesis that each cluster is on its own evolutionary trajectory is also supported by the fact that the population clusters are separated by an uninhabitable lower-elevation matrix that impedes gene flow. These isolated clusters may be experiencing genetic drift along with any differences in selective pressures.

In addition, all three population clusters demonstrate morphological differences among pollen grains (Fig. 7). The individual plants in the northern population also tended to be larger than the southern (Ch. 1) in number of rosettes, number inflorescences, flowers/fruits per inflorescence (Ch. 1). Although the southwestern variety *macrocarpa* was not included in this in-depth morphological study of the variety *asterophora*, it appeared to have much larger fruits at least (hence the number *macrocarpa*). These differences may be due to the unique ploidy levels, as other genera in Brassicaceae have also found larger pollen for higher ploidy levels (e.g. Windham and Al-Shehbaz 2006) and ployploid vigor could contribute to larger plants (Gu, Yang, Meng, and Zhang 2005; Parisod, Holdregger, and Brochmann 2010).

Overall, our findings suggest that the three regions of *D. asterophora* are genetically and cytologically distinct from one another and on their own evolutionary trajectories. These results support treating each as its own separate taxonomic entity, especially for conservation purposes. We propose that each of the distinct population clusters be recognized at the varietal level. We propose that *D. asterophora* should consist of three distinct varieties. The diploid southern population cluster should be pulled out of *D. asterophora* var. *asterophora* and should be given its own varietal name (type locality for *D. asterophora* var. *asterophora* is in the northern cluster).

Implications for Conservation

The *Draba asterophora* complex demonstrates that autopolyploidy may result in separate evolutionary trajectories (Soltis and Soltis 2009; de Quieroz 2007). Our data reveal the three geographically disjunct and cytogenetically distinct entities. As

separately evolving lineages, each of the three geographically isolated population clusters within the *D. asterophora* complex should be treated as a separate taxonomic entity for conservation purposes. Each taxa is very rare and needs to be independently managed as unique species. Therefore, we feel that it is critical for each cluster be recognized taxonomically as a separate variety. The diploid population cluster in the south is of particular concern and interest for conservationists as it may be the source of new species (Hansen, 2002; Soltis et al. 2007) including auto- and allo- polyploid hybrids.

LITERATURE CITED

- ALLENDORF, F. W. AND G. LUIKERT. 2007. Conservation and the Genetics of Populations. Blackwell Publishing: Malden, MA, USA.
- AL-SHEHBAZ, I. A. 1984. The tribes of Cruciferae (Brassicaceae) in the southeastern United States. *Journal of the Arnold Arboretum* 65:343–373.
- AL-SHEHBAZ, I. A. 1987. The genera of Alysseae (Cruciferae; Brassicaceae) in the southeastern United States. *Journal of the Arnold Arboretum* 68:185–240.
- BAILEY C. D., M. A. KOCH, M. MAYER, K. MUMMENHOFF, S. L. O’KANE JR., S. I. WARWICK, AND M. D. WINDHAM. 2006. Toward a global phylogeny of the Brassicaceae. *Molecular Biology and Evolution* 23:2142-2160.
- BAUM, D.A. AND K.L. SHAW. 1995. Genealogical perspectives on the species problem. In *Experimental and Molecular Approaches to Plant Systematics*, ed. P.C. Hoch, A.G. Stephenson, pp. 289-303. Missouri Botanical Garden: St. Louis.
- BAUM, D.A. AND M.J. DONOGHUE. 1995. Choosing among alternative “phylogenetic” species concepts. *Systematic Botany* 20:560-73.
- BEILSTEIN, M. A., I. A. AL-SHEHBAZ, AND E. A. KELLOGG. 2006. Brassicaceae phylogeny and trichome evolution. *American Journal of Botany* 93:607-619.
- BEILSTEIN, M. A., M. D. WINDHAM. 2003. A phylogenetic analysis of Western North American *Draba* (Brassicaceae) based on nuclear ribosomal DNA sequences from the ITS region. *Systematic Botany* 28(3): 584-592.

- BROCHMANN C., L. BORGEN, B. STEDJE. 1993. Crossing relationships and chromosome numbers of Nordic populations of *Draba* (Brassicaceae), with emphasis on the *D. alpina* complex. *Nordic Journal of Botany* 13:121–147.
- BROCHMANN, C., A.K. BRYSTING, I.G. ALSOS, L. BORGEN, H.H. GRUNDT, A.-C. SCHEEN, AND R. ELVEN. 2004. Polyploidy in arctic plants. *Biological Journal of Linnean Society* 82(4):521-536.
- BROWER, A.V.Z. 1999. Delimitation of phylogenetic species with DNA sequences: a critique of Davis and Nixon's population aggregation analysis. *Systematic Biology* 48:199-213.
- BULT, C., M. KÄLLERSJÖ, Y. SUH. 1989. Amplification and sequencing of 16/18S rDNA from gel-purified total plant DNA. *Plant Molecular Biology Reporter* 10(3):273-284.
- COTA, J. H. AND C. T. PHILBRICK. 1994. Chromosome number variation and polyploidy in the genus *Echinocereus* (Cactaceae). *American Journal of Botany* 81(8): 1054-1062.
- CRONQUIST, A. 1968. *The Evolution and Classification of Flowering Plants*. Boston, Houghton Mifflin Company.
- DAUBENMIRE, R. F. 1943. Vegetational zonation in the Rocky Mountains. *Botanical Review* 9: 325-393.
- DE QUEIROZ, K. 1998. Species concepts and species delimitation. *Systematic Biology* 56(6):879-886.
- DE QUEIROZ, K. 2005. Different species problems and their resolution. *BioEssays* 27: 1263-1269.

- DE QUEIROZ, K. 2007. Species concepts and species delimitation. *Systematic Biology* 56 (6): 879-886.
- EDGAR, R.C. 2004. MUSCLE: multiple sequence alignment with high accuracy and high throughput. *Nucleic Acids Research* 32: 1792-97.
- FELSENSTEIN J. 1985. Confidence limits on phylogenies: an approach using the bootstrap. *Evolution* 39: 783-791.
- GRANT V. 1981. *Plant Speciation*, 2nd ed. Columbia Univ. Press, New York.
- GU, X.F., A.F. YANG, H. MENG, J.R. ZHANG. 2005. In vitro induction of tetraploid plants from diploid *Zizyphus jujube* Mill. Cv. Zhanhua. *Plant Cell Reproduction* 24:671-676.
- HALVERSON, K., S. B. HEARD, J. D. NASON, AND J. O. STIREMAN, III. 2008. Origins, distributions and local co-occurrence of polyploidy cytotypes in *Solidago altissima* (Asteraceae). *American Journal of Botany* 95(1): 50-58.
- HAMRICK, J. L., J. D. NASON, T. H. FLEMING, AND J. M. NASSAR. 2002. Genetic diversity in columnar cacti. In Fleming, H. and A. Valiente-Banet, eds. *Columnar Cacti and Their Mutualists: Evolution, Ecology, and Conservation*. University of Arizona Press: Tuscon. Pp 122-133.
- HANSEN, C.J. L. ALLPHIN, M.D. WINDAM. 2002. Biosystematic analysis of *Thelesperma subnudum* complex (Asteraceae). *SIDA Contributions to Botany* 20:71-96
- HITCHCOCK, C.L. 1941. A revision of the *Drabas* of western North America. University of Washington Publications in Biology 11:1-132.
- HUSBAND, B.C. AND H.A. SABARA. 2003. Reproductive isolation between autotetraploids and their diploid progenitors in fireweed, *Chamerion augustifolium* (Onagraceae). *New Phytologist* 161(3):703-713.

- JANZEN, D. H., M. HAJIBABAEI, J. M. BURNS, W. HALLWACHS, E. REMIGIO, AND P.D.N. HERBET. 2005. Wedding biodiversity inventory of a large and complex Lepidoptera fauna with DNA barcoding. *Philosophical Transactions of the Royal Society B.*, 360: 1835-1845.
- Jiao, Y., N.J. Wickett, S. Ayyampalayam, A.S. Chanderbali, L. Landherr, P.E. Ralph et al. 2011. Ancestral polyploidy in seed plants and angiosperms. *Nature* 473:97-100.
- JOHNSON, L.A. AND H. CAIRNS-HEATH. 2010. Decrypting cryptic species: morphological and molecular evidence for recognizing *Navarretia linearifolia* as distinct from *N. sinistra* (Polemoniaceae). *Systematic Botany* 35(3):618-628.
- JOHNSON, L.A., D. GOWEN, AND A.B. JENSEN. 2013. Cryptic speciation: distinguishing serpentine affiliated sister species *Navarretia paradoxiclara* and *N. parasoxinota* from *N. intertexta* (Polemoniaceae). *Phytotaxa* 91(2):27-38.
- JOHNSON, L.A., L.M. CHAN, K. BURR, AND D. HENDRICKSON. 2012. *Navarretia furnissii* (Polemoniaceae), a new diploid species from the intermountain western United States distinguished from tetraploid *Navarretia saximontana*. *Phytotaxa* 42:51-61.
- JOHNSON, M. 2002. Genetic variation within and among populations of *Draba burkei* sp. nov. (Brassicaceae) in northern Utah: a conservation genetics study using enzyme electrophoresis. M.S. thesis. Provo, UT: Brigham Young University.
- JORDAN-THADEN, I., HASE, I., AL-SHEHBAZ, I., AND M. KOCH. 2010. Molecular phylogeny and systematics of the genus *Draba* (Brassicaceae) and identification of its closest related genera. *Molecular Phylogenetics and Evolution* 55: 524-540.

- KEELER, K.H. & DAVIS, G.A. 1999. Comparison of common cytotypes of *Andropogon gerardii* (Andropogoneae, Poaceae). *American Journal Botany* 86: 974–979.
- KOCH M., I. A. AL-SHEHBAZ, K. MUMMENHOFF. 2003. Molecular systematics, evolution, and population biology in the mustard family (Brassicaceae). *Annals of the Missouri Botanical Garden*. 90: 151-171.
- KOCH M., I. A. AL-SHEHBAZ. 2002. Molecular data indicate complex intra- and intercontinental differentiation of American *Draba* (Brassicaceae). *Annals of the Missouri Botanical Garden*. 89:88–109.
- MACARTHUR, R.H., AND E.O. WILSON. 1967. *The Theory of Island Biogeography*. Princeton University Press, Princeton, New Jersey, USA.
- MADDISON, W. P. AND D.R. MADDISON. 2011. Mesquite: a modular system for evolutionary analysis. Version 2.75 <http://mesquiteproject.org>
- MAJURE, L., W. JUDD, P. SOLTIS, AND D. SOLTIS. 2012. Cytogeography of the Humifusa clade of *Opuntia* s.s. Mill. 1754 (Cactaceae, Opuntioideae, Opuntieae): correlations with Pleistocene refugia and morphological traits in a polyploidy complex. *Comparative Cytogenetics* 6(1):53-77.
- MOORE, T. C. (1965). Origin and Disjunction of the alpine tundra flora on San Francisco Mountain, Arizona. *Ecology* 46:860-864.
- MULLIGAN G.A. 1976. The genus *Draba* in Canada and Alaska: key and summary. *Canadian Journal of Botany* 54:1386–1393.
- MULLIGAN, G.A. 1966. Chromosome numbers of the family Cruciferae. III. *Canadian Journal of Botany* 44:309-319.

- MULLIGAN, G.A. 1972. Cytotaxonomic studies of *Draba nivalis* and its close allies in Canada and Alaska: *D. oligosperma* and *D. incerta*. Canadian Journal of Botany 50:1763-1801.
- MULLIGAN, G.A. 1974. Cytotaxonomic studies of *Draba nivalis* and its close allies in Canada and Alaska. Canadian Journal of Botany 52:1793-1801.
- MÜNTZING, A. 1936. The evolutionary significance of autopolyploidy. Hereditas 21(2-3):363-378.
- OTTO, S.P. AND J. WHITTON. 2000. Polyploid incidence and evolution. Annual Review of Genetics 34:401-437.
- PARISOD, C., R. HOLDEREGGER, AND C. BROCHMANN. 2010. Evolutionary consequences of autopolyploidy. New Phytologist 186(1):5-17.
- RAMSEY, J. AND D. W. SCHEMSKE. 1998. Pathways, mechanisms, and rates of polyploid formation in flowering plants. Annual Review of Ecology and Systematics 29: 467–501.
- ROLLINS R. C. 1993. The Cruciferae of Continental North America. Stanford University Press: Stanford.
- RONQUIST, F. AND J.P. HUELSENBECK. 2003. MRBAYES 3: Bayesian phylogenetic inference under mixed models. Bioinformatics 19: 1572–1574.
- SCHEMSKE, D. W. 2000. Understanding the origin of the species. Evolution 54: 1069-1973.
- SEQUENCHER® version 5.1 sequence analysis software, Gene Codes Corporation, Ann Arbor, MI USA <http://www.genecodes.com>

- SITES, J.W. AND J.C. MARSHALL. 2003. Delimiting species: a Renaissance issue in systematic biology. *Trends in Ecology and Evolution* 18(9):262-469.
- SITES, J.W. AND J.C. MARSHALL. 2004. Operational criteria for delimiting species. *Annual Review of Evolutionary Systematics* 35:199-227.
- SITES, J.W. AND K.A. CRANDALL. 1997. Testing species boundaries in biodiversity studies. *Conservation Biology* 11(6):1289-1297.
- SOLTIS D.E., AND P.S. SOLTIS. 1993. Molecular data and the dynamic nature of polyploidy. *Critical Review of Plant Science* 12:243–273.
- SOLTIS D.E., P.S. SOLTIS, D. W. SCHEMSKE, J. HANCOCK, J. THOMPSON, B. C. HUSBAND, AND W.S. JUDD. 2007. Autopolyploidy in angiosperms: Have we grossly underestimated the number of species? *Taxon* 56: 13–30.
- SOLTIS, D.E. AND L.H. RIESEBERG. 1986. Autopolyploidy in *Tolmiea menziesii* (Saxifragaceae): genetic insights from enzyme electrophoresis *American Journal of Botany* 73: 310-318.
- SOLTIS, D.E. AND P.S. SOLTIS. 1999. Polyploidy: recurrent formation and genome evolution. *Trends in Ecological Evolution* 14: 348–52.
- SOLTIS, D.E., P.S. SOLTIS, AND J.A. TATE. 2003. Advances in the study of polyploidy since Plant speciation. *New Phytologist* 161:173-191.
- SOLTIS, P.S. AND D.E. SOLTIS. 2009. The role of hybridization in plant speciation. *Annual Review of Plant Biology* 60: 561-588.
- SOLTIS, P.S., AND D.E. SOLTIS. 2000. The role of genetic and genomic attributes in the success of polyploids. *Proceedings of the National Academy of Science USA* 97: 7051–7057.

- STEBBINS, G.L. 1950. Variation and evolution in plants. Columbia University Press: New York, New York, USA.
- SWOFFORD, D.L. 1999. PAUP*: Phylogenetic analysis using parsimony, version 4.0. Sinauer Associates: Sunderland, Massachusetts.
- WIENS, J.J. 2007. Species delimitation: new approaches for discovering diversity. *Systematic Biology* 56 (6): 875-878.
- WILEY, E.O. AND B.S. LIEBERMAN. 2011. Phylogenetics: Theory and Practice of Phylogenetic Systematics. Wiley: Singapore.
- WINDHAM M. D. 2000. Chromosome counts and taxonomic notes on *Draba* (Brassicaceae) of the Intermountain West. 1: Utah and vicinity. *Madroño* 47:21–28.
- WINDHAM M. D. 2003. Chromosome counts and taxonomic notes on *Draba* (Brassicaceae) of the Intermountain West. 2: Idaho, Nevada and vicinity. *Madroño* 50:221–231.
- ZOMLEFER, W.B, W. M. WHITTEN, N. H. WILLIAMS, AND W. S. JUDD. 2006. Infrageneric phylogeny of *Schoenocaulon* (Liliales: Melanthiaceae) with clarification of cryptic species based on ITS sequence data and geographical distribution. *American Journal of Botany* 93(8):1178-1192.

FIGURES AND TABLES

TABLE 1: Information on Taxon Sampling of *Draba* species and outgroup here studied. Species and associated *genBank* accession numbers together with some relevant characters sates under study. FC = Flower color (P=purple; W = white; Y = yellow); CC = Chromosome count. (continued on following pages)

Genus	Species	ITS	<i>trnS-trnG</i>	<i>trnH-psbA</i>	FC	CC (2n)
Outgroups						
<i>Aubrieta</i>	<i>deltoidea</i>	AJ232909			P	16
<i>Arabis</i>	<i>alpina</i>	AY134170			W	16
White-Flowered Euploids						
<i>Draba</i>	<i>breweri</i>	DQ467519.1				
<i>Draba</i>	<i>cana</i>	AY047665			W	32
<i>Draba</i>	<i>fladnizensis</i>	X	X	X	w	16
<i>Draba</i>	<i>glabella</i>	AF14686			W	64/80
<i>Draba</i>	<i>lonchocarpa</i> var.	1=35; 2=77				
<i>Draba</i>	<i>lonchocarpa</i>	AY04767.1	X	X	W	16
<i>Draba</i>	<i>lonchocarpa</i> var.					
<i>Draba</i>	<i>exuiqua</i>	AY047674.1				16a
<i>Draba</i>	<i>nivalis</i>	AY134133			W	16
<i>Draba</i>	<i>pennellii</i>		X		W	32
<i>Draba</i>	<i>platycarpa</i>	X				
<i>Draba</i>	<i>oreibata</i>	X	X		W	32
<i>Draba</i>	<i>ramosissima</i>	X			w	16
<i>Draba</i>	<i>reptans</i>	X				16,32, 30
Yellow-Flowered Euploids						
<i>Draba</i>	<i>alpina</i>	X			Y	80
<i>Draba</i>	<i>aizoides</i>	X				16
<i>Draba</i>	<i>bruniifolia</i>	AY04766			Y	16
<i>Draba</i>	<i>maguirei</i>	X		X	Y	16,32
<i>Draba</i>	<i>nemorosa</i>	AY134088			Y	16
<i>Draba</i>	<i>oligosperma</i>	AF146491			Y/W	32, 64
Yellow-Flowered Aneuploids						
<i>Draba</i>	<i>abajoensis</i>		X	X	Y	n=10
<i>Draba</i>	<i>albertina</i>	X		X	Y	24
<i>Draba</i>	<i>asprella</i>	X	X	X	Y	30
<i>Draba</i>	<i>asprella</i> var.					
<i>Draba</i>	<i>stelligera</i>	X				

TABLE 1. Continued

Genus	Species	ITS	<i>trnS- trnG</i>	<i>trnH- psbA</i>	FC	CC (2n)
<i>Draba</i>	<i>asterophora</i> var. <i>asterophora</i> (N)	X	X		Y	20
<i>Draba</i>	<i>asterophora</i> var. <i>asterophora</i> (S)	X	X	X	Y	20
<i>Draba</i>	<i>asterophora</i> var. <i>macrocarpa</i> (Sw)	X	X	X	Y	20
<i>Draba</i>	<i>aureola</i>	AF146509			Y	20
<i>Draba</i>	<i>aurea</i>	X	X	X	Y	74
<i>Draba</i>	<i>crassifolia</i>	AF146482; AY047666.		X	Y	40
<i>Draba</i>	<i>burkei</i>	AY047684.1		X	Y	20
<i>Draba</i>	<i>crassa</i>	X	X	X	Y	24
<i>Draba</i>	<i>cusickii</i>			X	Y	26
<i>Draba</i>	<i>graminea</i>			X	Y	18
<i>Draba</i>	<i>helleriana</i>	X	X	X	Y	18
<i>Draba</i>	<i>lemonii</i>	X			Y	
<i>Draba</i>	<i>mogollonica</i>	AF146490	X	X	Y	22
<i>Draba</i>	<i>pedicellata</i>	X				20
<i>Draba</i>	<i>sobolifera</i>	1				26
<i>Draba</i>	<i>sphaerocarpa</i>	1		X	Y	20
<i>Draba</i>	<i>sobolifera</i>	X			Y	26
<i>Draba</i>	<i>spectabilis</i> var. <i>oxyloba</i>			X		
<i>Draba</i>	<i>spectabilis</i> var. <i>spectabilis</i>	AY0476	X		Y	40
<i>Draba</i>	<i>sphaeroides</i>	1	X	X	Y	20
<i>Draba</i>	<i>streprocarpa</i>	x		X	Y	20,40
<i>Draba</i>	<i>paysonii</i> var. <i>treleasei</i>	AF146494			Y	42
<i>Draba</i>	<i>ventosa</i>	AF146495	X	X	Y	36
<i>Draba</i>	<i>densifolia</i>	AF146485; AF146510.1	X	X	Y	36
White-Flowered Aneuploids						
<i>Draba</i>	<i>Cuneifolia</i>			X		
<i>Draba</i>	<i>cunefolia</i> var. <i>cunefolia</i>	X	X	X	W	30, 32
<i>Draba</i>	<i>cunefolia</i> var. <i>integrifolia</i>	X		x	W	30
<i>Draba</i>	<i>jaegeri</i>				W	54
<i>Draba</i>	<i>juniperina</i>	AY047671	X	X	W	22
<i>Draba</i>	<i>kassii</i>	AY047672			W	22
<i>Draba</i>	<i>serpentina</i>				W	52
<i>Draba</i>	<i>subalpina</i>	AY047683		X	W	26

TABLE 1. Continued

Genus	Species	ITS	<i>trnS- trnG</i>	<i>trnH- psbA</i>	FC	CC (2n)
Polyploid Hybrids						
<i>Draba</i>	<i>alberti</i>	X			Y	?
<i>Draba</i>	<i>globosa</i>	X			X	
<i>Draba</i>	<i>hitchcockii</i>	x			W	54
<i>Draba</i>	<i>streptobrachia</i>	X1= DQ467562.1	X	X	Y	~64
<i>Draba</i>	<i>pPaysonii</i>	X			Y	?
<i>Draba</i>	<i>ramulosa</i>	X			Y	?
						2n=3
<i>Draba</i>	<i>argyrea</i>		X		Y	6
<i>Draba</i>	<i>sharsmithii</i>		X		Y	36
<i>Draba</i>	<i>brachystylis</i>	AY047663.1				
<i>Draba</i>	<i>lasiocarpa</i>	AY134195				
<i>Draba</i>	<i>hystrix</i>	AY134194				
<i>Draba</i>	<i>cachemiricia</i>	AY134192				
<i>Draba</i>	<i>yunnanensis</i>	AY134191				
New species						
<i>Draba</i>	<i>nova</i> – from Hindsdale, CO		X			
<i>Draba</i>	<i>aureaxunknown</i>		X			
<i>Draba</i>	<i>New species3</i>		X			
<i>Draba</i>	<i>New species? NM</i>		X			

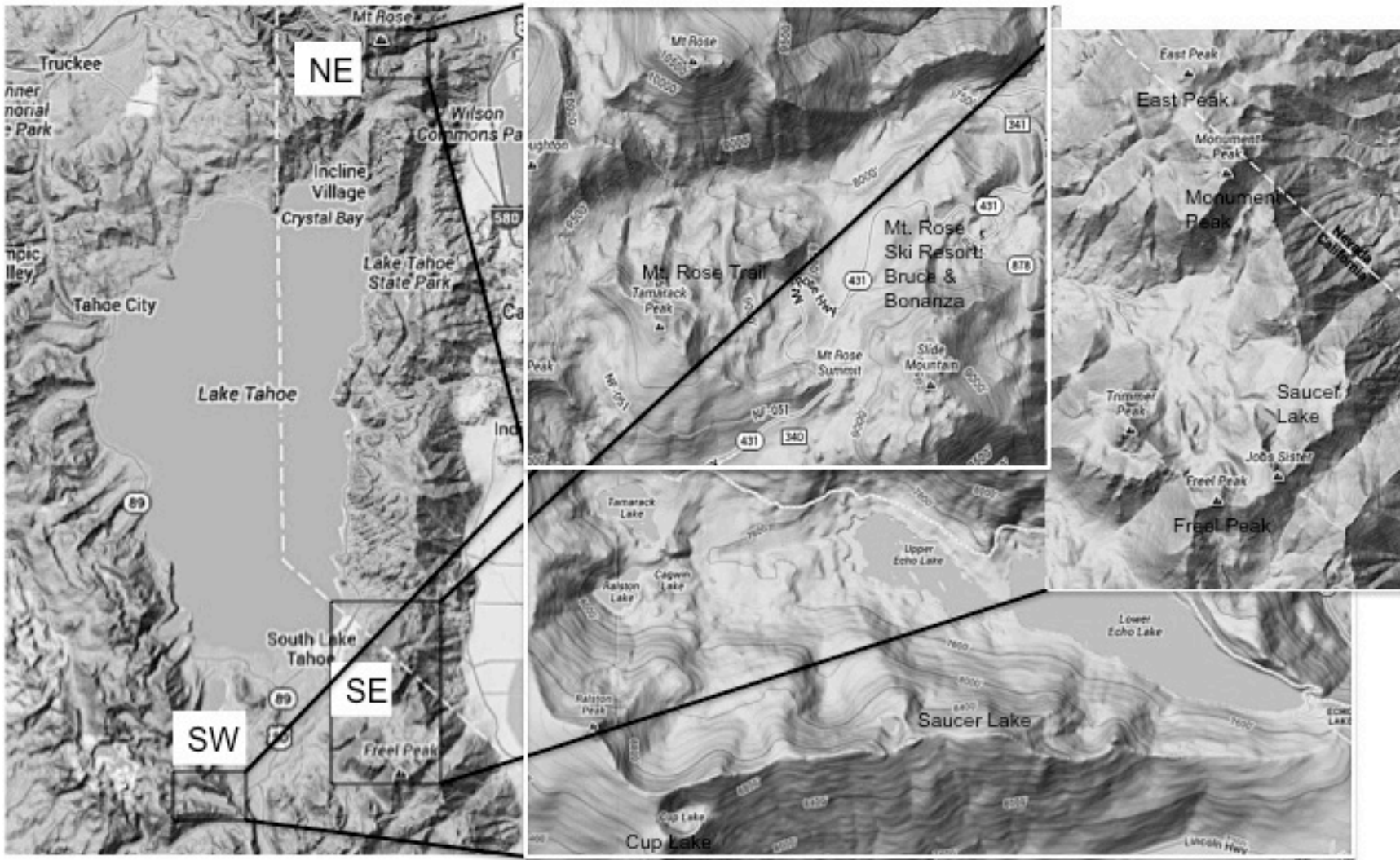
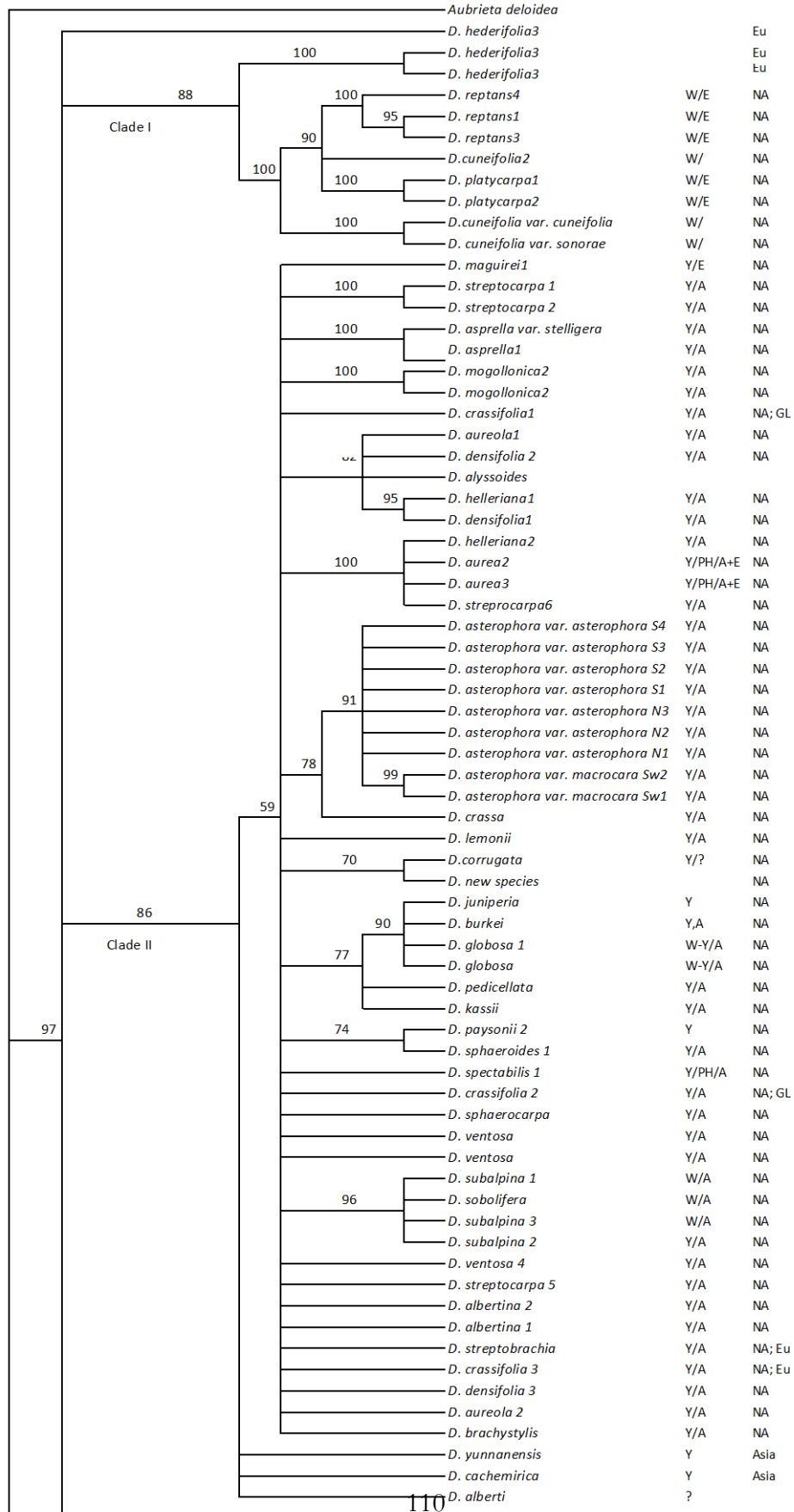

Fig. 1. Map of the three geographically distinct clusters of *D. asterophora* surrounding Lake Tahoe. (Photo credit: google maps; maps.google.com)



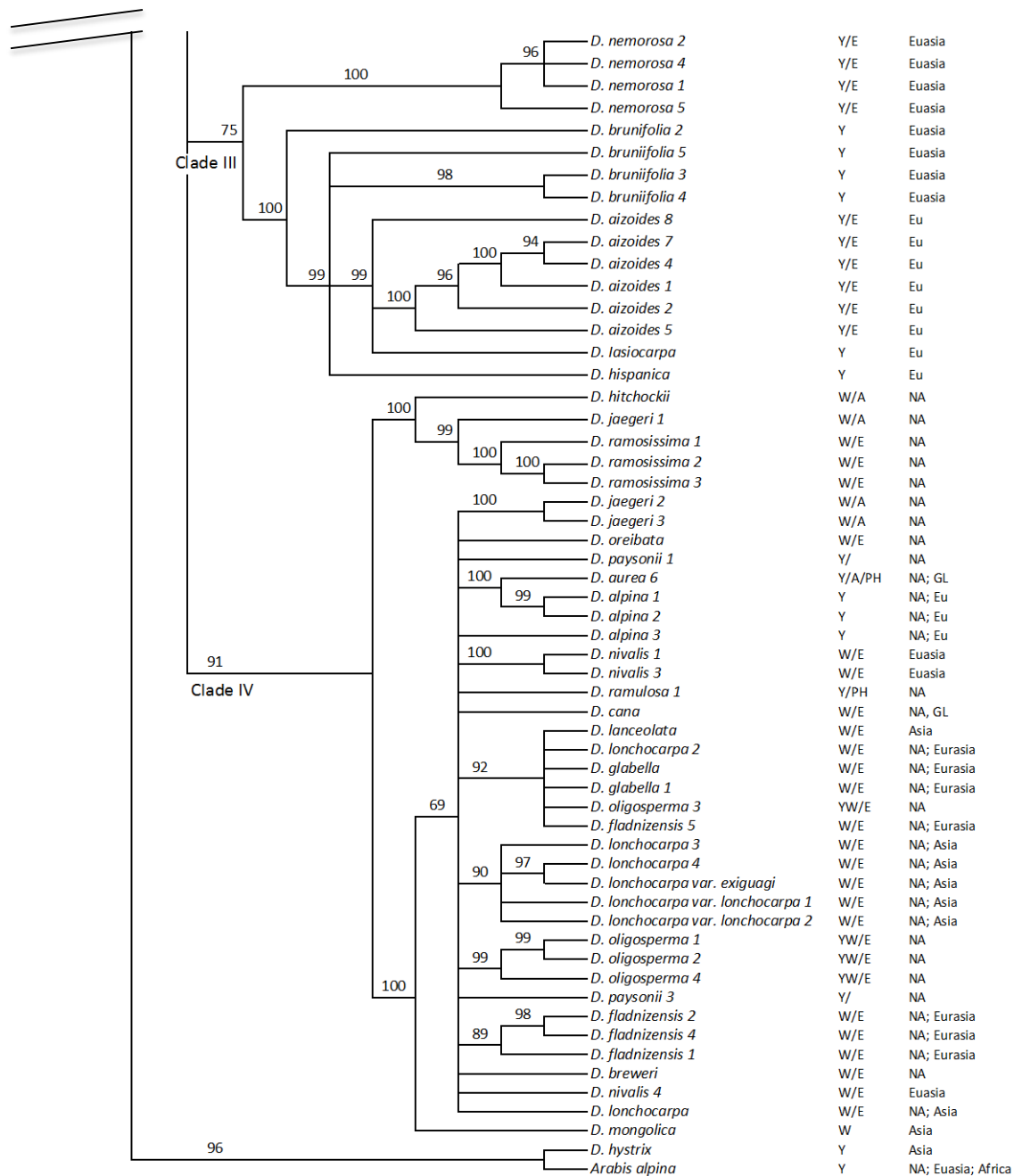

Fig. 2. Phylogenetic tree based on the ITS dataset (Bayesian posterior probabilities shown above branches). The only difference in species placement between the three types of analyses, was that in maximum likelihood analysis *D. paysonii*2 emerged sister to *D. mogollonica* and *D. sphaerdes* was sister to the entire branch (versus *D. paysonii*2 and *D. sphaeroides* forming their own separate branch). W = white flowers; Y = yellow flowers; E= euploid chromosome counts ($x=8$); A=aneuploid chromosome counts ($x\neq 8$); NA=North America, GL=Greenland, Eu=Europe. For *D. asterophora*., N=northern population cluster, S=southern population cluster, SW=southwest population cluster (variety *macrocarpa*).

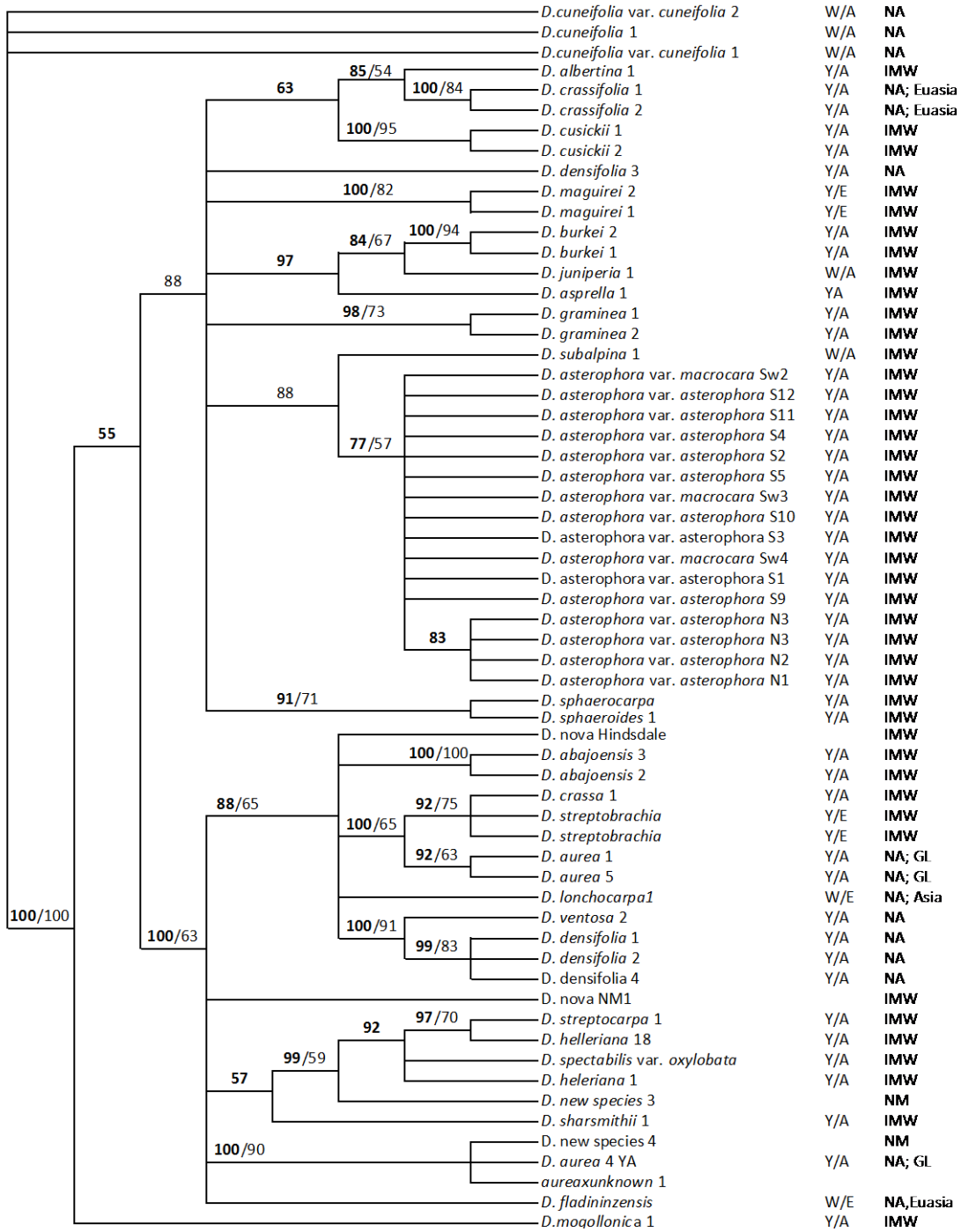

Fig. 3. Phylogenetic tree based on chloroplast molecular marker *trnH-pabA*. (**Bayesian posterior probabilities/Maximum Likelihood** above the branches). W = white flowers; Y = yellow flowers; E= euploid chromosome counts ($x=8$); A=aneuploid chromosome counts ($x\neq 8$), NA=North America; IMW=Intermountain West; GL=Greenland. For the *D. asterophora* population clusters, N=northern cluster, S=southern cluster, Sw=southwest cluster (variety *macrocarpa*)

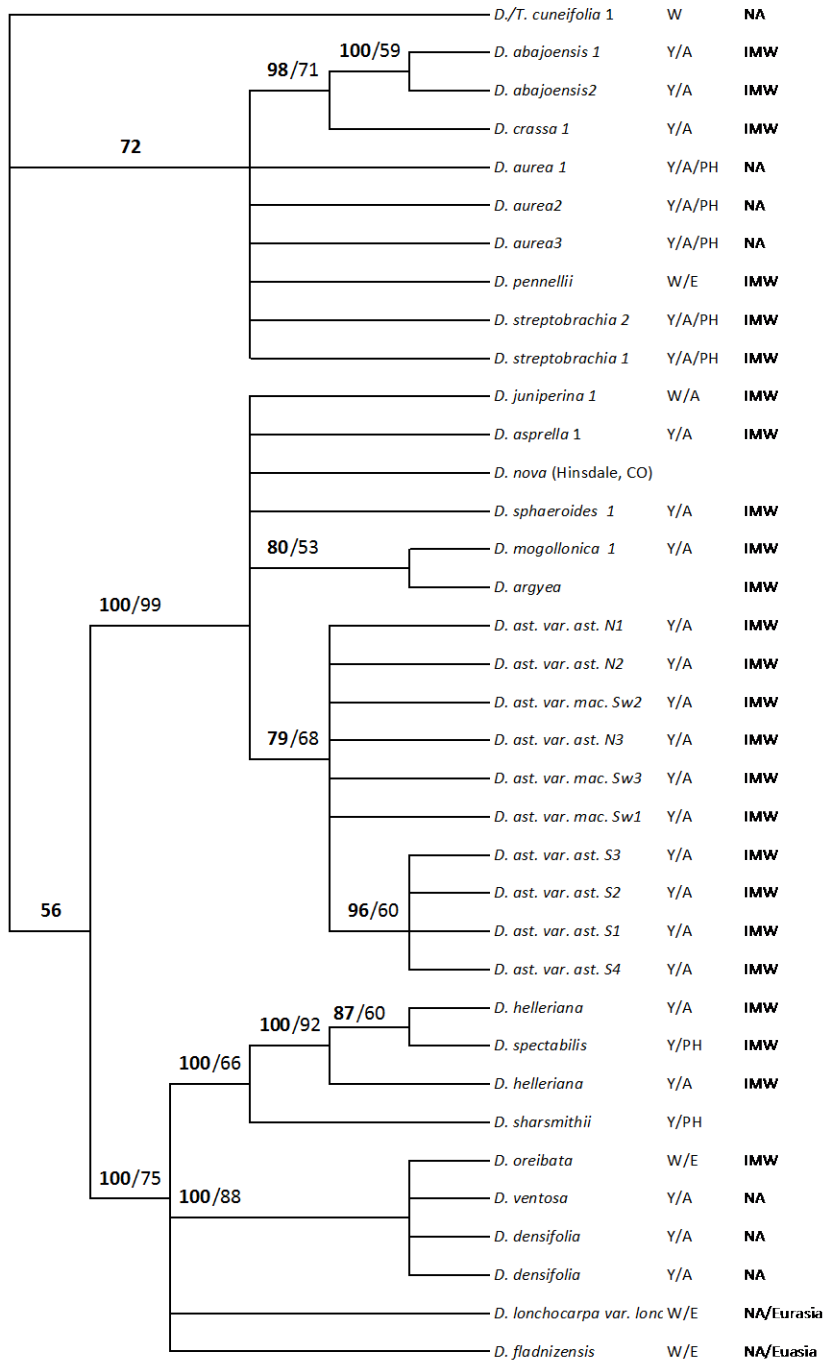

Fig. 4. Phylogenetic tree based on the chloroplast molecular marker *trnS/G* (**Bayesian posterior probabilities/Maximum Likelihood** above branches). W =white flowers; Y =yellow flowers; E= euploid chromosome counts ($x=8$); A=aneuploid chromosome counts ($x\neq 8$); IMW=Intermountain West; NA=north America. For the *D. asterophora* population clusters, N=northern cluster, S=southern cluster, SW=southwest cluster (variety *macrocarpa*)

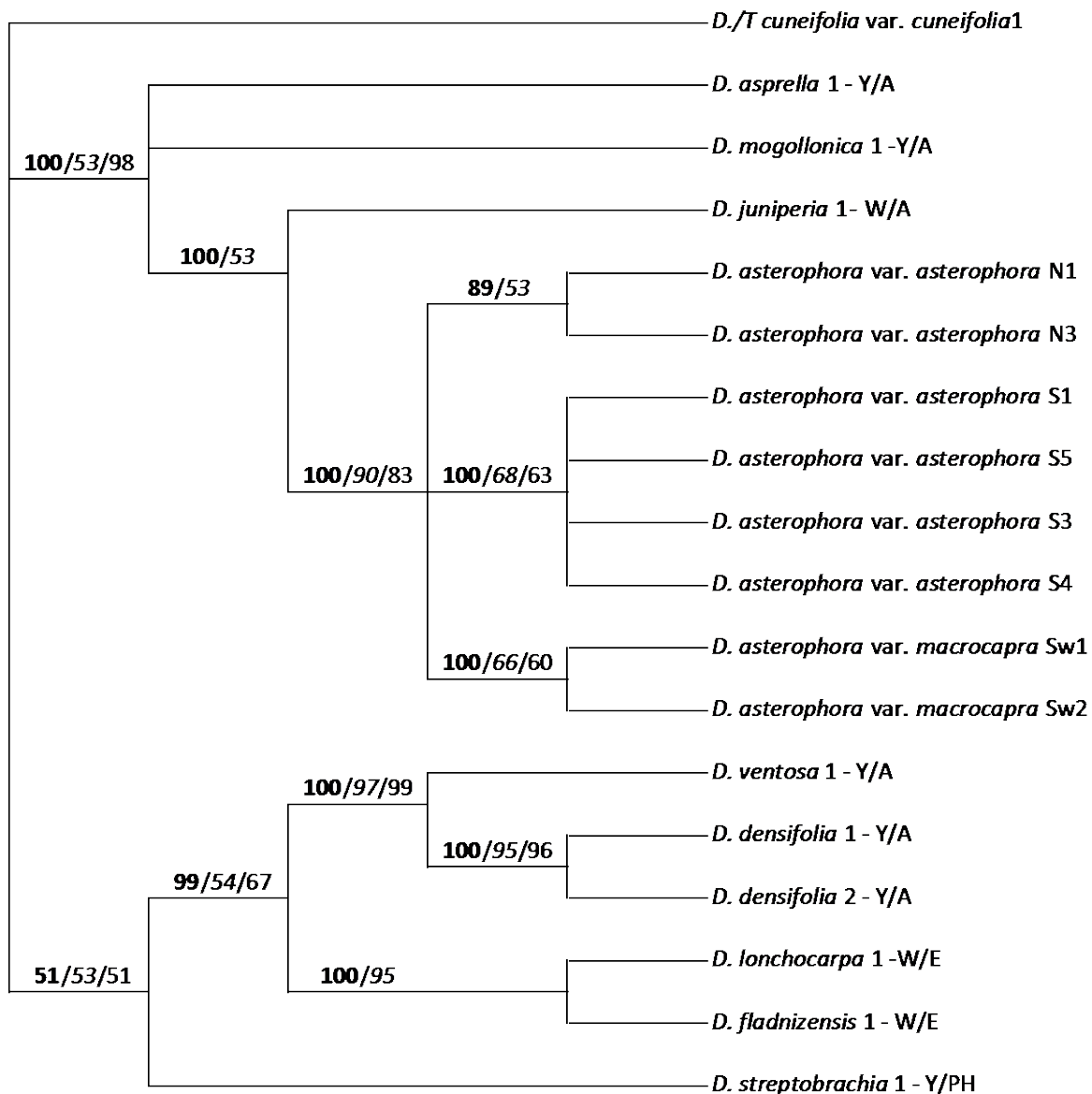

Fig. 5. Phylogenetic tree based on the combined concatenated data set (**Bayesian posterior probabilities/Maximum parsimony/Maximum likelihood bootstrap probabilities** above the branches). W = white flowers; Y = yellow flowers; E= euploid chromosome counts ($x=8$); A=aneuploid chromosome counts ($x\neq 8$). In reference to the *D. asterophora* population clusters, N=northern population cluster, S=southern population cluster, SW=southwest population cluster (variety *macrocarpa*).

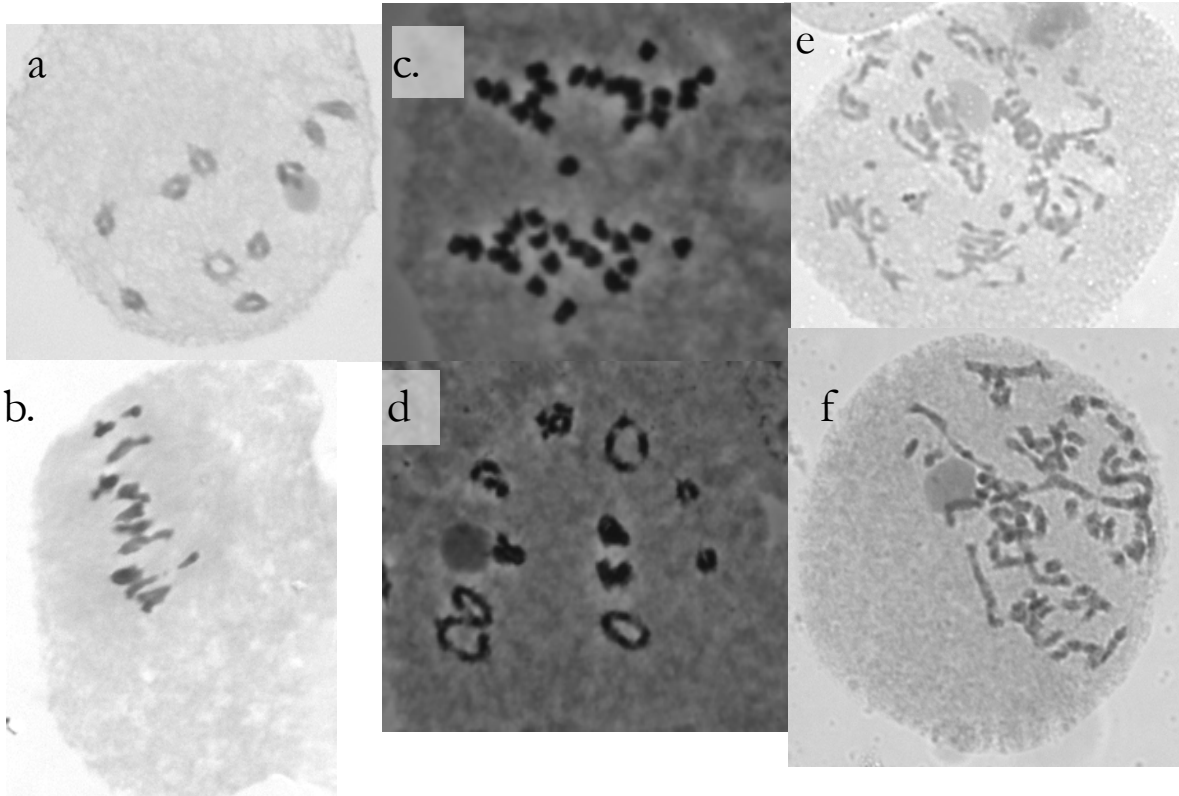

Fig. 6. Chromosome counts for *Draba asterophora*. a and b. *Draba asterophora* var. *asterophora* meiotic pollen cells in anaphase I from the southern region: a. shows diploid chromosome counts ($2n=20$, $x=10$), b. demonstrates triploid chromosome counts from the Star Lake population. c and d. *Draba asterophora* var. *asterophora* meiotic pollen cells from the northern region (Bruce ski run site) indicating autotetraploidy. c. meiotic pollen cell in anaphase I showing $n=20$, d. meiotic pollen cell at diakinesis with nine quadrivalents and two bivalents. e. and f. *Draba asterophora* var. *macrocarpa* meiotic pollen cells in prophase I from the southwest region (Ralston Peak) demonstrating octoploid chromosome counts. (Photos courtesy of Michael Windham, Ph.D.)

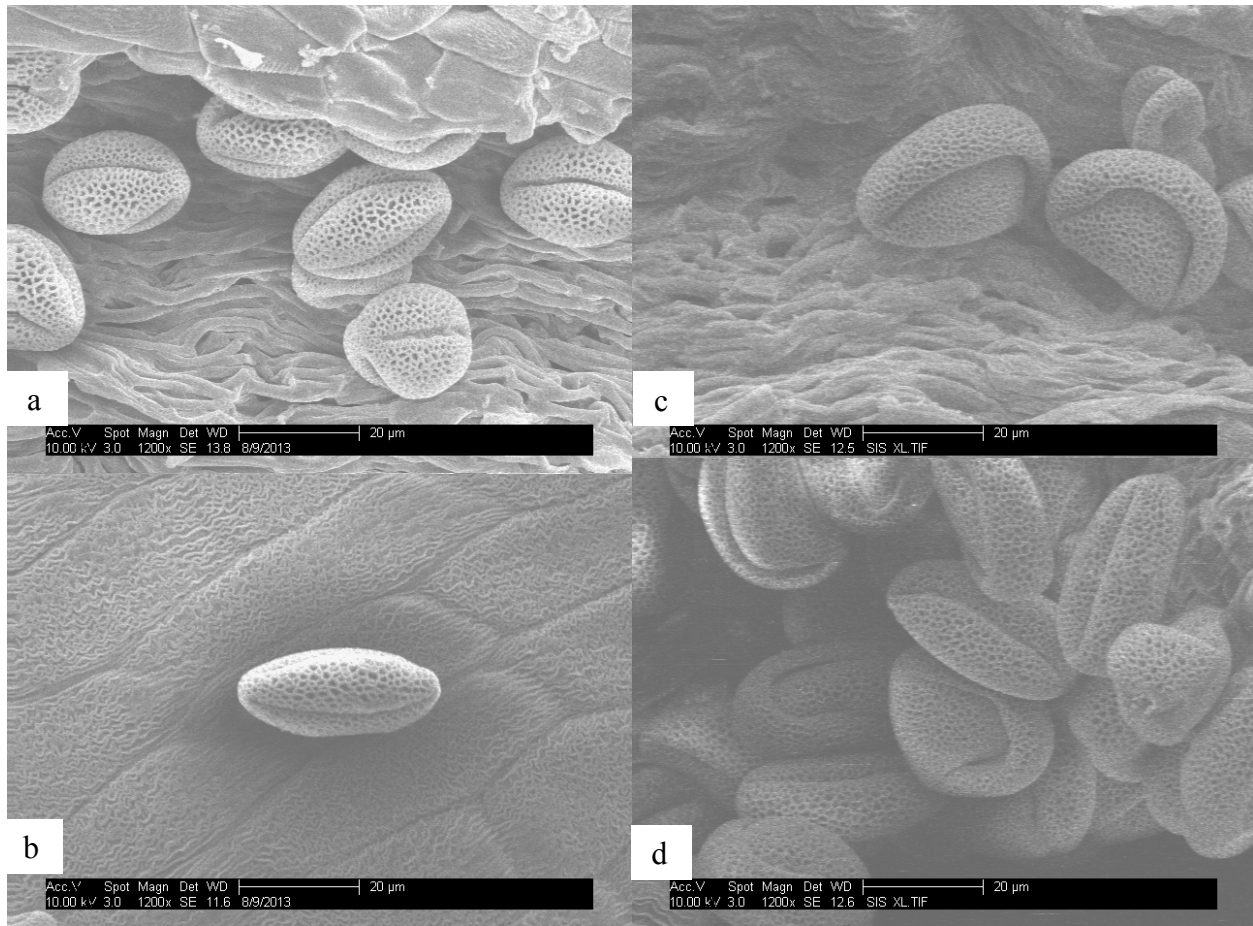

Fig. 7. SEM micrographs of pollen in *Draba asterophora* (all at 1200x magnification). a. pollen from the diploid southern population cluster. b. pollen grains from the tetraploid northern population cluster. c. and d. pollen from the octoploid southwestern population cluster (var. *macrocarpa*).